

# On Deck Sports®

SINCE 2001

Helping Coaches

# COACH

since 2001



**FALL 2018**

BASEBALL & SOFTBALL EQUIPMENT

# TABLE OF CONTENTS

Indoor Sports Facility Design.....	4-5	Fencing Accessories.....	45
The On Deck Difference.....	6-7	Baseballs.....	46-48
Artificial Turf For Sports Facilities.....	8	Softballs.....	49-51
Facility Netting.....	9	Training Aids.....	52-60
Pitching Mounds.....	10-14	Helmets.....	61-63
Batting Practice Platforms.....	15	Pitching Machines.....	64-69
Softball Pitching Mats.....	16-17	Bats.....	70-73
Outdoor Batting Cages.....	18-21	Baseball Racks.....	74-75
Indoor Batting Cages.....	22-23	Bases & Plates.....	76-78
Batting Mats.....	24-25	Catcher's Gear.....	79-80
On Deck Circles.....	26	Equipment Bags.....	80
Portable Backstops.....	27	Foul Poles.....	81
Home Plate Halos.....	28-29	Field Equipment.....	82-84
Protective Screens.....	30-33	Rubber Flooring.....	85
Windscreens.....	34-35	Agility Turf.....	86-87
Field Covers.....	36-41	Bleachers.....	88-89
Indoor/Outdoor Padding.....	42-43	Benches.....	90-91
Fencing.....	44		

## HOW CAN WE HELP?



Batting Cages - Pages 18-23



Screens - Pages 30-33



Pitching Machines - Pages 64-69



Batting Mats - Pages 24-25



PVTee™ - Page 52



The Designated Hitter™ - Page 53



Pitching Mounds - Pages 10-14



Bats - Pages 70-73



Fencing - Pages 44-45



## TABLE OF CONTENTS

# CUSTOMIZE YOUR FIELD



Home Plate Halos - Pages 28-29



Windscreens - Pages 34-35

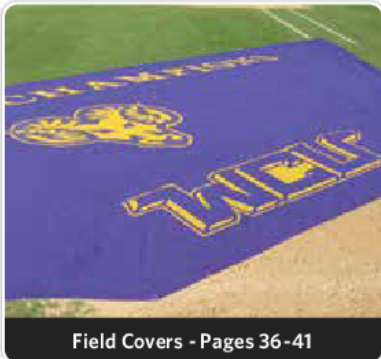

Field Covers - Pages 36-41

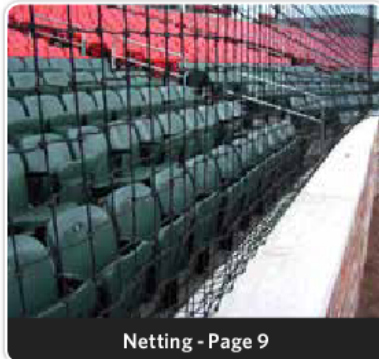

Netting - Page 9

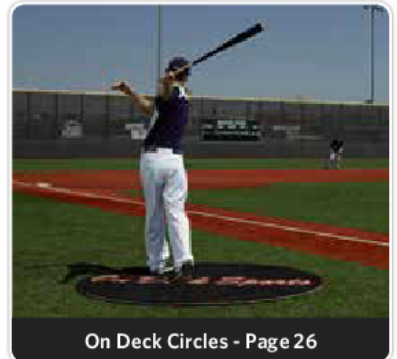

On Deck Circles - Page 26



INDOOR SPORTS FACILITY DESIGN

# DESIGN

## THE INDOOR FACILITY OF YOUR DREAMS

Check out our Facility Features



THE YARD  
LEXINGTON, KY

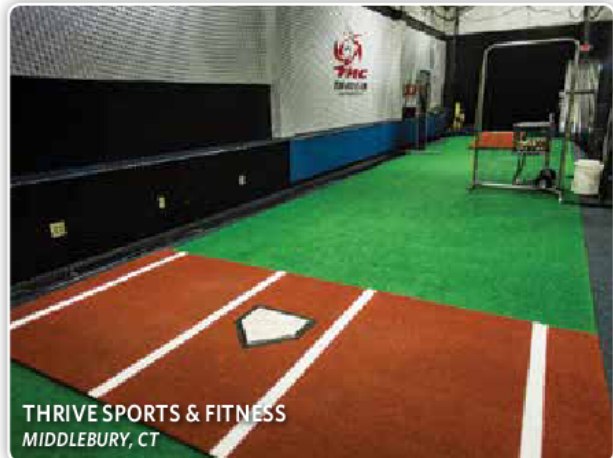

THRIVE SPORTS & FITNESS  
MIDDLEBURY, CT



GEORGIA OCTANE  
CUMMING, GA

.....  
"I am absolutely, 100% satisfied with my indoor facility. On Deck Sports walked me through the entire process from planning to design ideas and installation. They were tremendous to work with. During the building process, On Deck Sports came early and stayed late to get the job done. They absolutely over-delivered on our project and when I am ready to build again, I will be using On Deck Sports!"

*Travis Bailey, Owner - Georgia Octane - Cumming, GA*

“ ”

on [blog.ondecksports.com](http://blog.ondecksports.com)

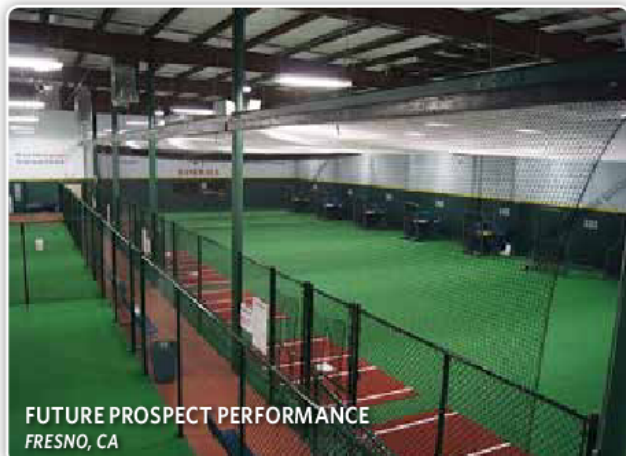

**FUTURE PROSPECT PERFORMANCE**  
FRESNO, CA

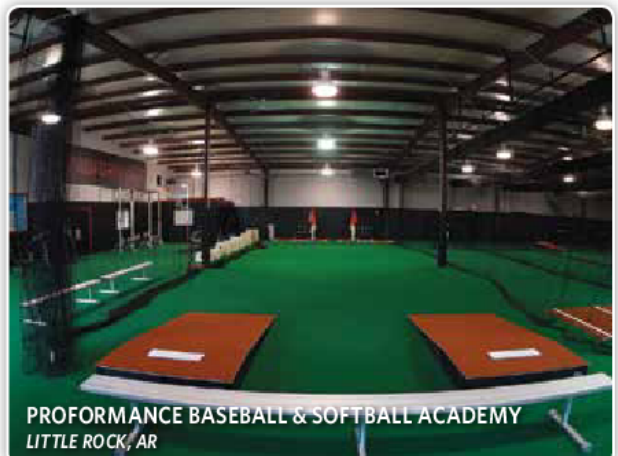

**PROFORMANCE BASEBALL & SOFTBALL ACADEMY**  
LITTLE ROCK, AR

# THE ON DECK

# DIFFERENCE

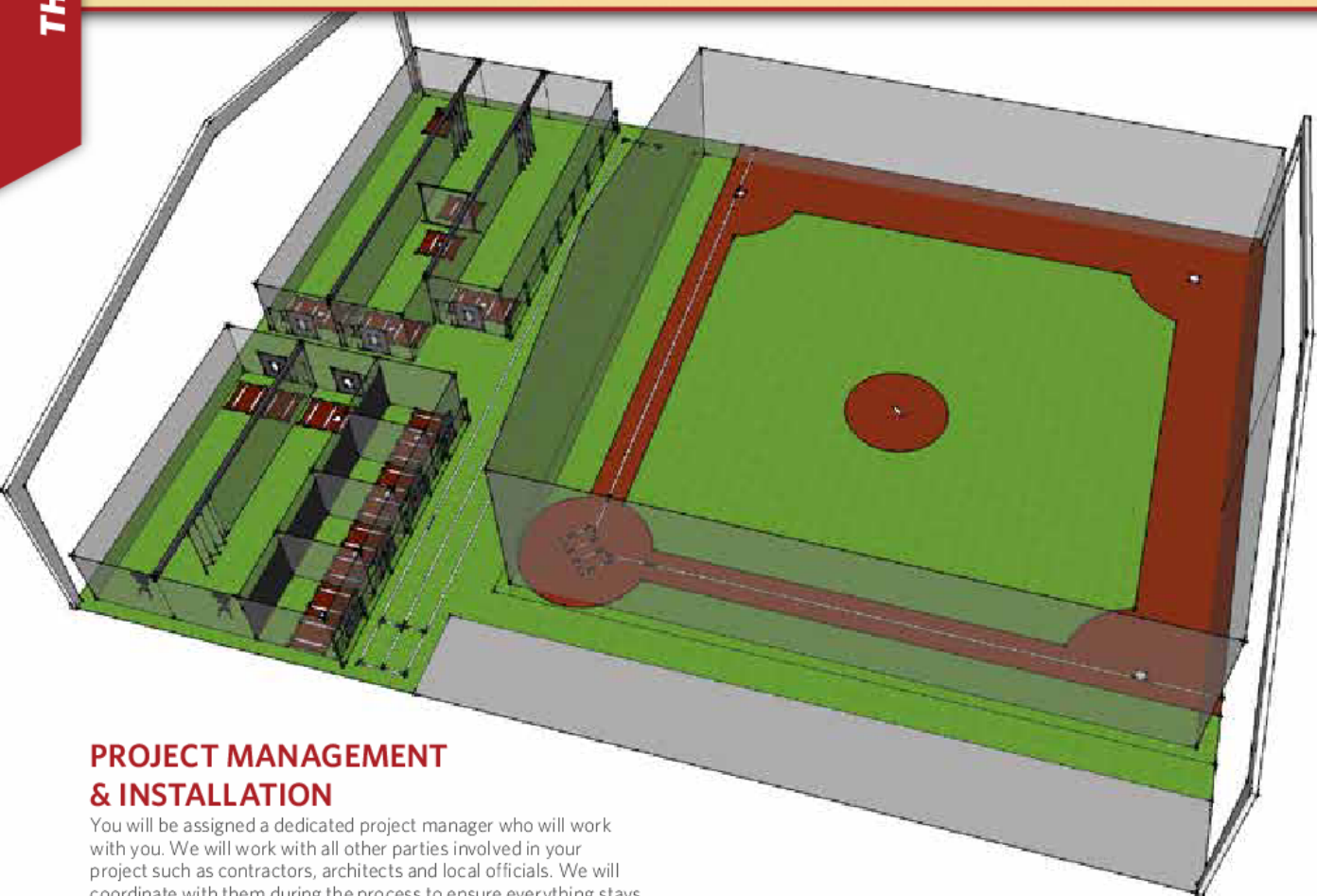

## PROJECT MANAGEMENT & INSTALLATION

You will be assigned a dedicated project manager who will work with you. We will work with all other parties involved in your project such as contractors, architects and local officials. We will coordinate with them during the process to ensure everything stays on schedule.

Our proven installation techniques are often imitated, but never matched. No detail is too small and our professional installation crews execute on plans endorsed by structural engineers. We take the time to ensure that all variables are considered and the safety of your athletes and staff is our top concern.



## EXPERIENCE, DESIGN EXPERTISE AND CUSTOM SOLUTIONS

Since 2001, we have worked with over 1,200 indoor sports facilities, taking their ideas from concept all the way to completion. Our indoor facility experts work and train in similar facilities and will share their expertise to optimize your space for safety, function and profitability.

- We offer a wide range of design suggestions for facilities of all sizes.
- We take the time to develop a custom plan that works for you.
- We will produce drawings and renderings to help visualize your facility prior to construction.



OVER 15 YEARS OF EXPERIENCE WITH OVER A THOUSAND FACILITIES OF ALL SHAPES AND SIZES

CUSTOM SOLUTIONS FOR EVERY PROJECT FROM DESIGN EXPERTS WHO WORK, TRAIN AND COACH IN THESE FACILITIES

ONE-STOP SHOPPING: TURF, NETTING, RUBBER FLOORING, PADDING, DIVIDER CURTAINS AND TRAINING EQUIPMENT

DIRECTLY-SOURCED PRODUCT OF THE HIGHEST QUALITY, CHOSEN SPECIFICALLY FOR YOUR DESIRED USE

DEDICATED PROJECT MANAGEMENT WITH PROFESSIONAL INSTALLATION CREWS ACROSS THE COUNTRY

### HERE'S WHAT SOME OF OUR CUSTOMERS HAVE TO SAY

*"The project team with On Deck Sports were available throughout the entire installation process. These guys came in on a Sunday night, after being away from home for several weeks. They knocked it out in a hurry, and made me feel relieved about choosing On Deck Sports."*

Mike Branch, Owner - Teddy Ballgames - South Bend, IN

*"We are very proud of the facility we created with the help of On Deck Sports, and it is a very popular place for the players in our area. We have many comments we could offer - most importantly that we could not have even dreamed of the end product without the design and installation services of On Deck Sports."*

Nicole Bankovich, Owner - The Baseball Bank - DuBois, PA

*"Working with On Deck Sports was great. I continue to order stuff from them. Also, your two installers are phenomenal. They made the install to my liking without me even needing to get involved. They're class guys who wanted world-class results and were really great to work with. Like many things, it's the installers that matter. Your guys really care and I wouldn't ever do this again without working with your guys."*

John Adams, Owner - Batter Up CT - Guilford, CT

*"Top of the line service and equipment. On Deck has been around for a long time and has the experience and expertise needed to assemble a premier facility. I would give On Deck my highest recommendation. From placing the order to installing the equipment it was a great experience."*

Frank Velasquez, Director of Sports Performance - Allegheny Health Network, Pittsburgh, PA



### BEST IN CLASS PRODUCTS

We will outfit your facility with the highest quality netting and artificial turf on the market. Our products go through rigorous testing and quality control to ensure they hold up to the day-to-day stresses of a high-traffic indoor sports facility. We use only industrial-grade hardware in all of our installations and cut no corners with product quality. We also offer a wide range of custom options, such as placing your logo in turf or on rubber flooring, padding or windscreen. Our facility experts will work with you to select the best specifications to fit your uses, needs and budget.

And, once you open, our training aids, pitching machines, protective screens and team equipment will ensure a state-of-the-art experience for your athletes. We offer only the best products and brands in each category.

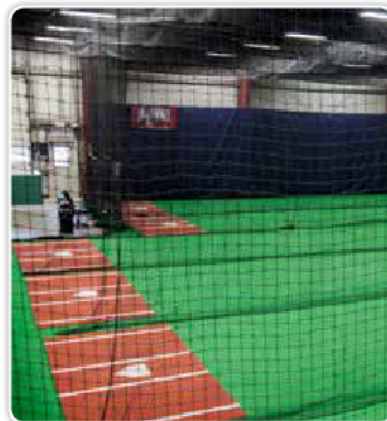

### WE STAND BY OUR WORK

Perfection is our goal, but if for any reason you are unsatisfied with our work or any of our products, we will make it right. On Deck Sports has been in business since 2001 because of our reputation for quality work and customer satisfaction. We understand the enormity of your project and will be your partner in every aspect.

**Put your trust in a partner who has worked with over a thousand other customers just like you.**

# ARTIFICIAL TURF FOR SPORTS FACILITIES



## 12' GT34 Padded Artificial Turf

GT34 is our most popular turf option for indoor facilities. The polyethylene yarn provides the softest feel while still holding up to heavy traffic. A 5mm foam pad allows the turf to react more like real grass than unpadded turf options, making GT34 extremely popular for any sports facility.

Face Weight: 34 oz.  
Pile Height: 1/2"  
Yarn Type: Polyethylene  
Backing: 5 mm Foam Backing  
Width: 12' Wide



**NTWFTXT34 - \$2.39/sq. ft**

## 12' Stadium Padded Artificial Turf

Stadium is a nylon turf product, making it one of the most durable options on the market. This allows Stadium to hold up in extremely high-traffic areas with little wear. A 5mm foam pad provides a cushion over your floor that makes this turf ideal for strength & conditioning areas in any facility.

Face Weight: 30 oz.  
Pile Height: 1/2"  
Yarn Type: Nylon  
Backing: 5 mm Foam Backing  
Width: 12' Wide



**NTOV1Stadium-5mm-12 - \$2.79/sq. ft.**

## 15' GT48 Padded Artificial Turf

With 48 ounces of yarn per square yard, GT 48 is a plusher version of its close relative GT34. The polyethylene yarn and 5mm foam pad provide a soft feel both under foot and with skin contact. Available in multiple colors, GT48 is a great option for anyone looking to add a custom look to their indoor facility.

Face Weight: 48 oz.  
Pile Height: 3/4"  
Yarn Type: Polyethylene  
Backing: 5 mm Foam Backing  
Width: 15' Wide



**NTWFTXT48 - \$3.19/sq. ft.**

## 15' Elite Padded Artificial Turf

Elite is our premium turf option and the ideal substitute for natural grass. It combines polypropylene and nylon yarns, giving it durability with a soft touch. Elite lives up to its name, providing a natural look and feel that your athletes will love. Perfect for full indoor fields, without the need for infill.

Face Weight: 58 oz.  
Pile Height: 1"  
Yarn Type: Polypropylene with nylon thatch  
Backing: 5 mm Foam Backing  
Width: 15' Wide



**NTWFElite - \$4.29/sq. ft**

## 12' Arena Padded Artificial Turf

Arena is one of our premium turf products, combining polypropylene and nylon yarns. It is soft to the touch, but durable enough to deal with high-traffic areas. This added strength makes Arena a great option for full field areas in your facility, but eliminates the need for messy infill products.

Face Weight: 40 oz.  
Pile Height: 3/4"  
Yarn Type: Polypropylene with Nylon Thatch  
Backing: 5 mm Foam Backing  
Width: 12' Wide



**NTWFArena - \$3.89/sq. ft**

Call a Sales Representative 800.365.6171 about velcro installations  
Samples of all turf products available upon request



After years of providing netting solutions, On Deck Sports understands that every athletic facility or field has a unique design and set of dimensions. Whether you speak with one of our netting specialists, or use our interactive custom netting calculator online, we will provide the ideal netting solution for your particular needs.

## WHAT MAKES OUR NETTING DIFFERENT?

- All of our netting is hung on the square, not the diamond. Looks better and hangs easier for a smoother install.
- Breaking strength of our netting is the strongest in the industry.
- Our inside-out technology helps maintain the breaking strength of our net throughout its life.

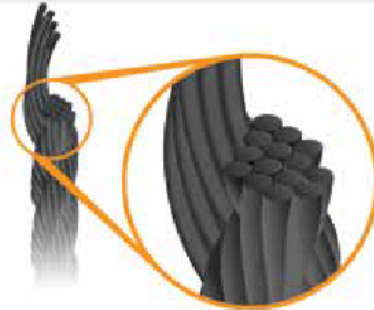

**ON DECK SPORTS UV PROTECTION**  
Black color represents UV protection

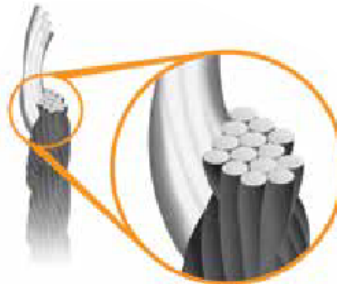

**COMPETITORS' DIPPED & DYED UV PROTECTION**

## INSIDE-OUT TECHNOLOGY

During the fabrication process, netting is protected with UV inhibitors and dyed a certain color. During our process, we coat and dye each individual strand of netting, therefore protecting the net from the inside out. This helps maintain its initial breaking strength. Most companies fabricate netting and then dip and dye-only protecting the outside of the net. Once the coating on the outside of the netting is broken down, the netting rapidly loses breaking strength and integrity.

## CUSTOM NETTING AVAILABLE

#18	BB/SB Mesh
#21	BB/SB Mesh
#36	BB/SB Mesh
#42	BB/SB Mesh
#48	BB/SB Mesh
#72	BB/SB Mesh
#96	BB/SB Mesh

Check out our online calculator for custom netting panels and cages



### Shell Cage

The shell cage is a ceiling-to-floor netting solution used to protect your facility and maximize your space. The net provides a protective barrier between the playing area and your ceiling, walls, windows, light fixtures, players and spectators. The shell can help you expand to a multi-sport facility.

Whether you want to build batting cages or divide playing fields, the shell cage allows you to do both. We install custom netting using a grid cabling system that attaches to the net and a grid rope to minimize the wear and tear on the nets. Our netting systems are custom developed and calculated for your building.

### Retractable Divider Netting

Underneath the shell cage you can install retractable divider netting. Our retractable netting panels divide your indoor turf field into batting cages or can create separate fields for multiple teams.

### Windscreen Barriers

Windscreen Barriers attach to the ceiling cables to fill the gap between the ceiling shell cage netting and the divider nets. This prevents balls from jumping from one cage to the next in the space between your ceiling netting and retractable divider curtain. This gives an added layer of safety for your players and coaches. The windscreen barriers also hide your hardware to give your netting a clean look.

# PITCHING MOUNDS

PITCHING MOUNDS

## PROMOUNDS<sup>®</sup>

### ProModel & Collegiate Practice Pitching Mounds

#### ProMounds ProModel Pitching Mound

- Solid, high-density foam core
- PRAT rubber coating
- Skid-proof
- Scuff-proof
- Durable construction
- Lightweight construction
- No damage to wood floors
- Easy to handle
- Portable
- Realistic pitching feel
- Not designed for use with metal spikes

MP2004 **GREEN** \$1,049.00  
MP2004C **CLAY** \$1,049.00

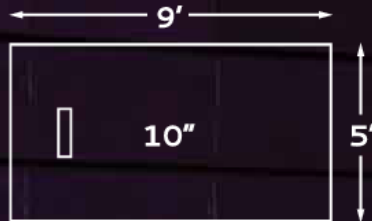

#### ProMounds Collegiate Pitching Mound

- Solid, high-density foam core
- PRAT rubber coating
- Skid-proof
- Scuff-proof
- Durable construction
- Lightweight construction
- No damage to wood floors
- Easy to handle
- Portable
- Not designed for use with metal spikes

MP2001 **GREEN** \$949.00  
MP2001C **CLAY** \$949.00





# PITCHING MOUNDS

## ProMounds Two-Piece Pitching Mound

- Solid, high-density foam core
- PRAT rubber coating
- Skid-proof
- Scuff-proof
- Durable construction
- Lightweight construction

- No damage to wood floors
- Easy to handle
- Portable
- Realistic pitching feel
- Not designed for use with metal spikes

MP2031 **GREEN** \$1,049.00  
MP2031C **CLAY** \$1,049.00

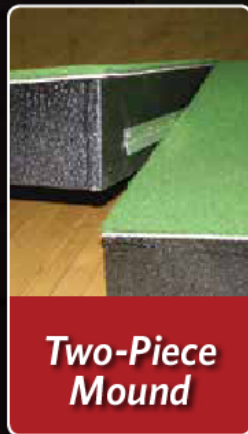
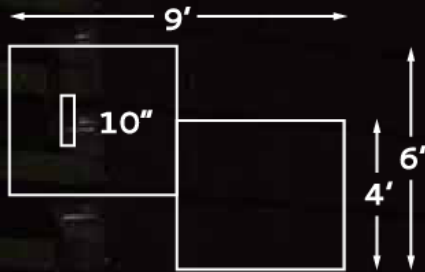

**Two-Piece  
Mound**



## PROMOUNDS Game Mounds

- Solid, high-density foam core
- PRAT rubber coating
- Can be used indoors or outdoors
- Convert field into a baseball field in minutes
- Green or clay
- Portable
- Lightweight
- Not designed for use with metal spikes



### ProMounds Major League Game Mound

- Solid, high-density foam core
- PRAT rubber coating
- Can be used indoors or outdoors
- "Land on the mound" design
- Official Little League mound specifications
- Convert field into a baseball field in minutes
- Green or clay
- Portable
- Lightweight
- Not designed for use with metal spikes

MP3003G **GREEN** \$1,149.00  
 MP3003C **CLAY** \$1,149.00

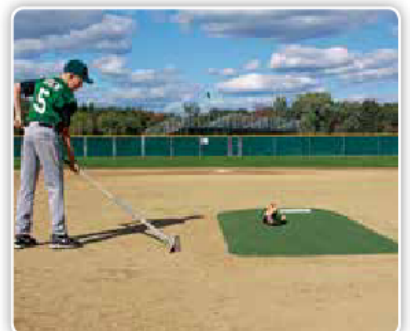
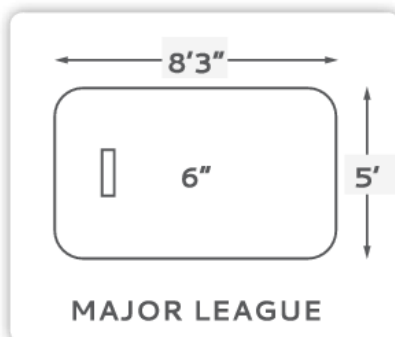



## ProMounds Minor League Game Mound

- Solid, high-density foam core
- PRAT rubber coating
- Can be used indoors or outdoors
- "Land on the dirt" design
- Extended size
- Convert field into a baseball field in minutes
- Green or clay
- Portable
- Lightweight
- Not designed for use with metal spikes

MP3002G **GREEN** \$899.00  
 MP3002C **CLAY** \$899.00



## ProMounds 5070 Game Mound

- Solid, high-density foam core
- PRAT rubber coating
- Can be used indoors or outdoors
- "Land on the dirt" design
- Convert field into a baseball field in minutes
- Green or clay
- Portable
- Lightweight
- Ships FedEx
- Not designed for use with metal spikes

MP5070G **GREEN** \$499.99  
 MP5070C **CLAY** \$499.99

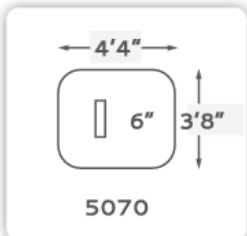

**Ships FedEx!**



## ProMounds Bronco Game Mound

- Solid, high-density foam core
- PRAT rubber coating
- Can be used indoors or outdoors
- "Land on the dirt" design
- Narrow size
- Convert field into a baseball field in minutes
- Green or clay
- Portable
- Lightweight
- Not designed for use with metal spikes

MP2029G **GREEN** \$799.00  
 MP2034C **CLAY** \$799.00

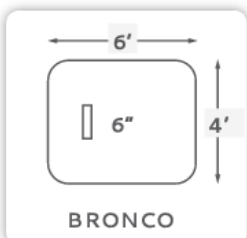

### ProMounds Training Mound

- Heavy-duty, high-density solid foam core
- PRAT rubber coating
- Can be used indoors or outdoors
- "Land on the dirt" design
- Narrow size
- Convert field into a baseball field in minutes
- Green or clay
- Portable
- Lightweight
- Not designed for use with metal spikes

MP3001G **GREEN** \$375.00  
 MP3001C **CLAY** \$375.00



### ProMounds Junior Pitching Mound

- Heavy-duty, high-density foam
- PRAT rubber coating
- Skid-proof
- Scuff-proof
- Durable construction
- Lightweight construction
- No damage to wood floors
- Easy to handle
- Portable
- Realistic pitching feel
- Not designed for use with metal spikes

MP2040C **CLAY** \$499.00

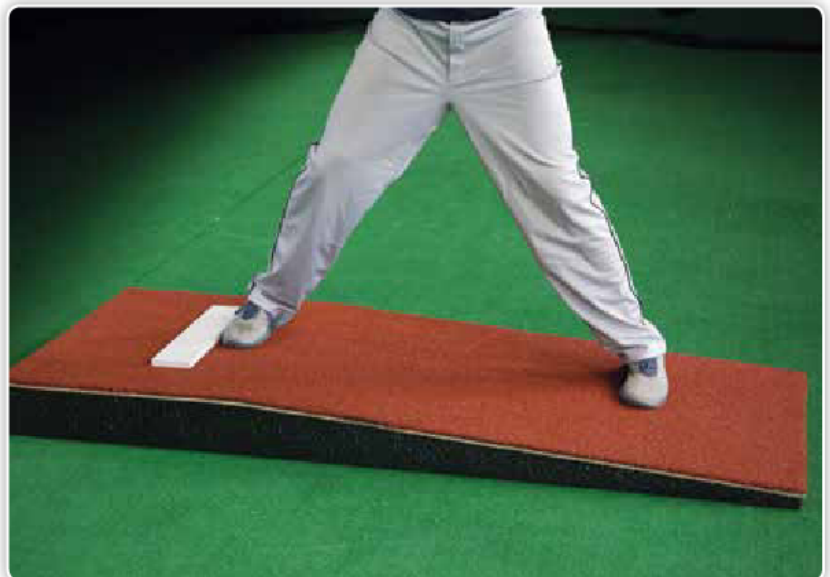
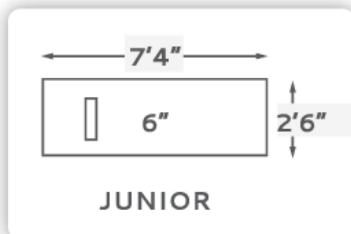





### ProMounds Portable Pitching Platforms

are ideal to protect your field during batting practice. Designed for outdoor use. Each platform is covered in spike-resistant artificial turf, includes a welded aluminum frame with an inset plywood base and is equipped with wheels for easy movement. The platforms also protect the grass in front of the mound.



Check out our protective screens on pages 30-33

#### (A) ProMounds ProModel Pitching Platform

7'L x 4.5'W x 6"H

Protect your field during batting practice. Made of a welded aluminum frame with a plywood inset covered in spike-resistant artificial turf. Equipped with pneumatic wheels and handles for easy movement.

**MP2006 - \$1,099.00**

#### (B) ProMounds Collegiate Pitching Platform

7'L x 3'W x 6"-10"H

Protect your field during batting practice. Telescoping legs that adjust from 6"-10" to accommodate youth or adult usage. Made of a welded aluminum frame. Covered in spike-resistant artificial turf. Equipped with pneumatic wheels for easy movement.

**MP2035 - \$690.00**



# SOFTBALL PITCHING MATS

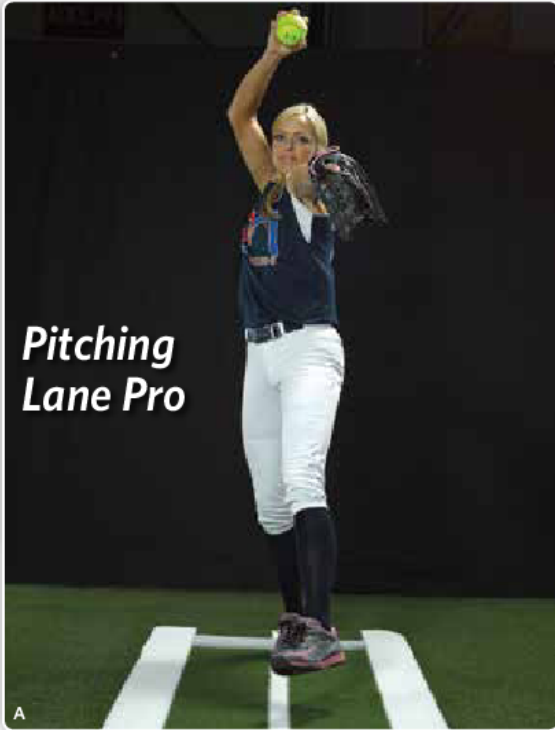

*Pitching Lane Pro*

A



*Mini-Mat*

C

## JENNIE FINCH PITCHING MATS FROM

# PROMOUNDS



*Pitching Mat with Powerline*

B



"The Softball Pitching Mat from ProMounds<sup>®</sup> is an amazing tool for pitchers at any level."

*Jennie Finch*  
Olympic Gold Medalist

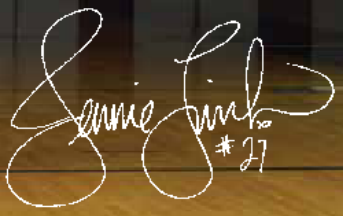

**NON-SLIP RUBBER BACKING**



**INLAID WHITE LINES**

**(A) Jennie Finch Softball Pitching Lane Pro**

Cushion backing allows pitchers to land on a consistent surface, reducing wear on the body. Helps pitchers comply with NCAA regulations (2.19) that restricts pitchers from pitching outside the 24" rubber. 6" barrier of white inlaid turf on either side of the rubber. Also the 2" inlaid white powerline, which allows for more precise training for pitchers of all ages. Includes a full-size pitching rubber. Comes with convenient carrying case. 3'W x 10'L.  
**MP3010 - \$249.00**

**(B) Jennie Finch Softball Pitching Mat with Powerline**

Cushion backing allows pitchers to land on a consistent surface, reducing wear on the body. 2" inlaid white center line for precise training. Attached full-size pitching rubber. Comes with a convenient carrying case. 3'W x 10'L.  
**MP2036 - \$225.00**

**Jennie Finch Foam Back Softball Pitching Mat with Powerline**

Features a foam backing for use on artificial turf. White inlaid center line for precise training. Comes with a full-size pitching rubber attached.  
**MP2038 - \$225.00**

**(C) Jennie Finch Softball Pitching Mini-Mat with Powerline**

Ultra-portable and affordable. Easily aligns with existing gym floor lines for precise training. Comes with an attached full-size pitching rubber. 3'W x 2'L.  
**MP3009 - \$95.00**

**(D) Finch Windmill**

- Promotes equal muscle balance • Injury prevention
  - More speed • Muscle recruitment • Gain strength and endurance
  - Complete workout in four minutes • Shoulder rehabilitation
  - Finch Windmills hold their value
- \$325.00 + S&H**

Call Toll-Free 866-258-2727  
Finch Windmill  
PO Box 97, La Mirada, CA 90637  
www.finchwindmill.com

**CONVENIENT CARRYING CASE FOR PITCHING MAT WITH POWERLINE AND PITCHING LANE PRO**



**OUTDOOR BATTING CAGES**



**ProMounds Batting Cage Kit**

The perfect batting cage for backyards, youth leagues, high schools and colleges. Netting available as either premium nylon or standard poly material. The premium nylon batting cages come with a lead core perimeter rope, a flap door (3' overlap), and a 12' x 14' backdrop. The lead core perimeter rope helps to weigh down the bottom of the cage, helping to keep it in place upon impact. ProMounds batting cage frames are constructed with 12-gauge piping. Call for more information.

<i>Standard Poly</i>	<i>12'H x 14'W x 35'L</i>	<i>Complete Package</i>	<i>SN9008</i>	<i>\$1,499.99</i>
<i>Standard Poly</i>	<i>12'H x 14'W x 55'L</i>	<i>Complete Package</i>	<i>SN9011</i>	<i>\$1,939.99</i>
<i>Standard Poly</i>	<i>12'H x 14'W x 70'L</i>	<i>Complete Package</i>	<i>SN9013</i>	<i>\$2,359.99</i>
<i>Premium Nylon</i>	<i>12'H x 14'W x 35'L</i>	<i>Complete Package</i>	<i>SN9009</i>	<i>\$1,649.99</i>
<i>Premium Nylon</i>	<i>12'H x 14'W x 55'L</i>	<i>Complete Package</i>	<i>SN9010</i>	<i>\$2,099.99</i>
<i>Premium Nylon</i>	<i>12'H x 14'W x 70'L</i>	<i>Complete Package</i>	<i>SN9012</i>	<i>\$2,499.99</i>



**ON DECK SPORTS BATTING CAGE SOLUTIONS**  
**FROM THE BACKYARD TO THE PROS. CONTACT ONE OF OUR EXPERTS TODAY!**





### Commercial Batting Cages

Designed with heavy-duty tubing, to withstand lots of extended use, high winds, and the elements better. Frame is designed around 2.875" OD, 8-gauge pipe uprights. Premium nylon grade batting cage nets that have a lead core rope around the bottom to keep the netting in place. Commercial-grade netting includes a flap door that allows easy but safe access to the batting cage. Backstop net will have a longer life with the included 12' x 14' backdrop net sewn into the top of the cage. Systems include: poles, netting, arch offsets, all hardware, and installation instructions.

12'H x 14'W x 55'L	Complete Package - with Soft Toss	SN6993	\$4,299.99
12'H x 14'W x 70'L	Complete Package - with Soft Toss	SN6994	\$5,299.99
12'H x 14'W x 55'L	Complete Package - No Soft Toss	SN9100	\$3,395.00
12'H x 14'W x 70'L	Complete Package - No Soft Toss	SN9101	\$3,995.00

## BATTING CAGE ADD-ONS

### Soft Toss Station

Heavy-duty knotless nylon nets with large capture sock to collect and retain batted balls. Galvanized steel cabling and attachment hardware.

4 Stations (70' Cage)	SN9130	\$1,099.99
3 Stations (55' Cage)	SN9129	\$899.99

### Tensioning Cuffs

Secure the nets at the corners to restrict win interference.

Single Cage (set of 4)	SN9135	\$239.99
Single Cage (set of 4 w/ Graphics)	SN9136	\$649.99

Custom printing available

### Replacement Netting

To make sure your batting cage nets are safe and secure, our netting is made of durable #36, 1-3/4" UV treated knotted square mesh and able to withstand heavy use and nearly any weather condition. This netting is ideal for all levels of play including college, high school, and youth.

12'H x 14'W x 70'L	SN6005	\$999.00
12'H x 14'W x 55'L	SN6006	\$899.00

### Commercial Double Batting Cage Package

Commercial Double Batting Cage Systems are available in 55' and 70' lengths. System includes: (2) premium nylon batting cage nets, commercial cage poles, and a commercial cage kit. The commercial cage kit includes: arch offsets, hardware, and installation instructions. All necessary hardware is included in the kits.

SN9105 - \$6,395.00

SN9110 - \$6,995.00

Replacement  
Batting Cage  
Netting Available

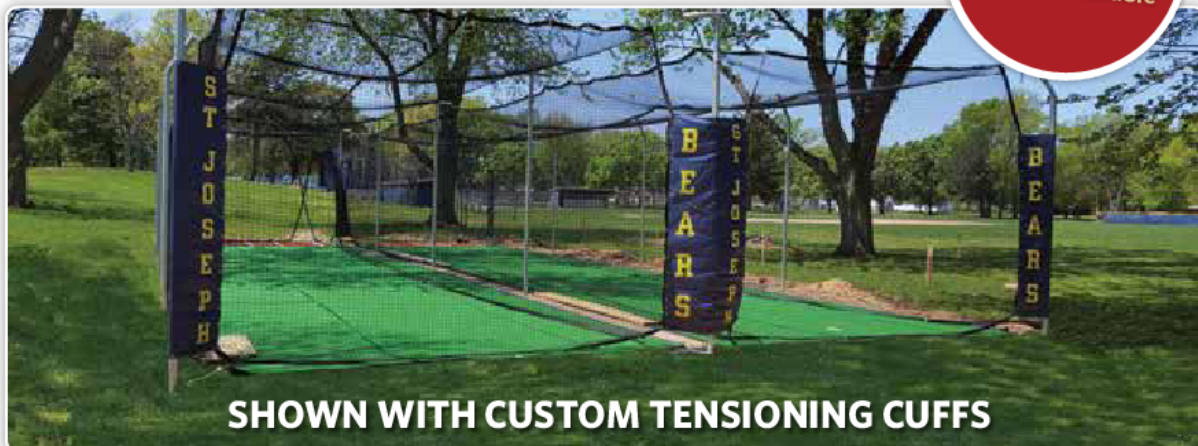

SHOWN WITH CUSTOM TENSIONING CUFFS



**Mastodon Batting Cage**

The batting cage frame system includes 8.625" OD steel pipes coated with the same finish used on the Trans-Alaska Pipeline. There are fewer components and it spans up to 85' in either direction, without significant sag. Poles come ready to attach tensioning hardware. Comes with premium #36 nylon netting, the most durable material on the market. Kit includes: steel poles, 3/16" galvanized aircraft cable (enough for a 14' x 85' footprint), cage netting and galvanized steel carabiners. A cable tensioning system ensures that your net will hang properly and needs no special tools. Poles are corrosion resistant. 20 year manufacturer's warranty on frame.

12'H x 14'W x 70'L	Single Wide	SN9118	\$6,229.00
12'H x 14'W x 75'L	Single Wide	SN9119	\$6,459.00
14'H x 14'W x 55'L	Single Wide	SN9124	\$6,999.00
14'H x 14'W x 70'L	Single Wide	SN9120	\$7,169.00
12'H x 14'W x 70'L	Double Wide	SN9121	\$10,599.00
12'H x 14'W x 75'L	Double Wide	SN9122	\$11,739.00
14'H x 14'W x 70'L	Double Wide	SN9123	\$12,479.00





## BATTING CAGE TURF

Call an On Deck Sports Sales Representative at 800.365.6171 for more information

### BCT 15' Unpadded Artificial Turf

The name says it all - our Batting Cage Turf (BCT) is the most popular option for outdoor batting cage solutions. It is a durable turf option that can withstand the rigors of everyday cage work, but is still available at a great price.

Face Weight: 18 oz.  
Pile Height: 3/8"  
Yarn Type: Polyethylene  
Width: 15' Wide  
**NTOV1BCT - \$1.25/sq.ft**



### GT34 12' Unpadded Artificial Turf

GT34 is our most popular turf option. The soft touch of the turf reduces injuries caused by friction. This easy-to-maintain product has great durability and is designed to withstand the rigors of daily use in high-traffic areas.

Face Weight: 34 oz.  
Pile Height: 1/2"  
Yarn Type: Polyethylene  
Width: 12' Wide  
**NTNFTXT34 - \$1.49/sq.ft**



### Cage 12' Unpadded Artificial Turf

Cage turf is a nylon turf option, making it the most durable and longest-lasting option for batting cage turf. This turf can withstand everyday cage use and not wear down. A great option for batting cages at all levels.

Face Weight: 30 oz.  
Pile Height: 1/2"  
Yarn Type: Nylon  
Width: 12' Wide  
**NTOVICAGE - \$1.69/sq.ft**



### GT48 15' Unpadded Artificial Turf

With 48 ounces of yarn per square yard, GT48 is a plusher version of its close relative GT34. Available in multiple colors, GT48 is a great option for anyone looking to add a custom look to their indoor facility.

Face Weight: 48 oz.  
Pile Height: 3/4"  
Yarn Type: Polyethylene  
Backing: 5 mm Foam Backing  
Width: 15' Wide  
**NTNFTXT48 - \$3.19/sq.ft.**



## BACKDROPS

### Vinyl Backdrop

The 40oz., 5'W x 6'H vinyl backdrop is perfect for any indoor or outdoor batting cage. The backdrop protects your batting cage nets, walls or anything behind the batting cage. Comes standard with a sewn-in strike zone target.

**SN6014 - \$89.99**

### Black Vinyl Backdrop

Perfect for any indoor or outdoor batting cage. Protects your batting cage net, walls, or anything behind the batting cage. 5'W x 6'H, 40oz vinyl.

**SN8005 - \$75.99**



Check out our online calculator for custom netting panels and cages

### CUSTOM NETTING AVAILABLE

Baseball/Softball Netting Gauge Options	
#18	Mesh
#21	Mesh
#36	Mesh
#42	Mesh
#48	Mesh
#72	Mesh
#96	Mesh

← MOST POPULAR!

See pages 30-33 to see our protective screen options

# NEED TO HIT



Permanent, retractable, or removable,



**Gym floor covering available**

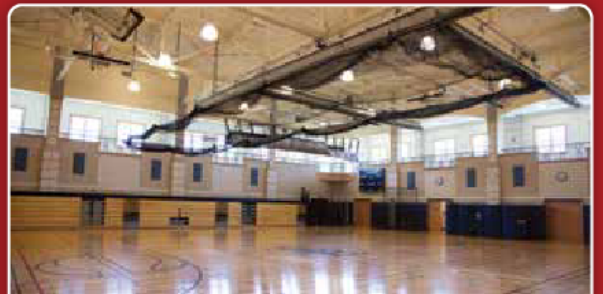

#### Ceiling Retractable Batting Cage

The Ceiling Retractable Batting Cages are the premium option. These operate using a key that powers a winch to raise and lower the cages. These cages can custom retract to mirror the angle of the roof of your building or can hang flat. These are the perfect solution for any multi-purpose area, after retracting these cages there is nothing left on the ground.



# INDOORS?

Professional installation available

Get your custom quote today

we have solutions for any budget



**Static Batting Cage**

Static Batting Cages are cages with permanent attachment points but the netting of the cage can be taken down for multi-purpose areas such as a high school gym. These cages are great for schools on a budget.

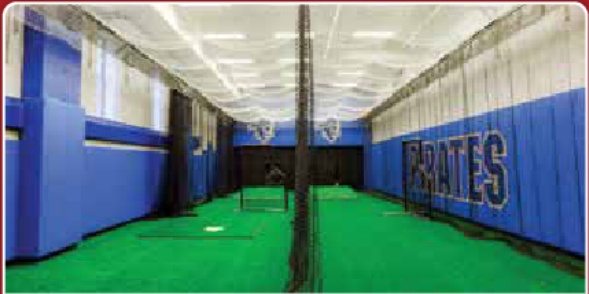

**Sliding Indoor Batting Cage**

There are two types of sliding indoor batting cages a cable system and a track system. These cages have permanent fixtures that allow you to slide the nets to one end of the cage setup to move it out of the way for other activities in a multiple purpose facility. These cages are great if you have a lane to setup your batting cage.



**(A) Batting Mat Pro**

A portable 12' x 6' artificial turf batting mat that is great for batting practice, both indoors and outdoors. This batting mat features a 5mm foam backing, white inlaid turf lines and a throw-down home plate. Throw-down home plate allows the mat to be rotated for minimum wear. Available in either green or clay.

ATS002	GREEN	\$315.00
ATS002C	CLAY	\$315.00



**(B) Softball Batting Mat Pro**

A portable 12' x 7' artificial turf batting mat that is great for batting practice, both indoors and outdoors. This batting mat features a 5mm foam backing, white inlaid turf lines and a throw-down home plate. Throw-down home plate allows the mat to be rotated for minimum wear. Available in either green or clay.

ATS007	GREEN	\$359.00
ATS007C	CLAY	\$359.00





### (A) Batting Mat Pro with Catcher's Extension

Provides a maintenance-free batting practice session. White lines are a combination of inlaid turf and paint. Features a 5 mm foam backing and a throw-down home plate. Catcher's extension is attached to the batting mat with 6' long sewn Velcro strips. Mat has Velcro on both sides of the extension so the entire unit can be rotated for maximum use and minimum wear. Easy to carry and store. Available in either green or clay.

AT6023G	GREEN	\$525.00
AT6023C	CLAY	\$525.00



### (B) Premium Batting Mats

Highest-quality turf available. Style and shade may vary.

12' x 6'	ATS001	GREEN	\$199.00
12' x 7'	ATS027	GREEN	\$225.00
3' x 7'	ATS029	GREEN	\$59.00
3' x 5'	AT6019	GREEN	\$49.00
4' x 12'	ATS028	GREEN	\$135.00
6' x 4'	ATS005	GREEN	\$69.00



### (C) Standard Batting Mats

Great for batting practice indoors or outdoors. Features a 5mm foam backing. Turf is made of a durable poly yarn. Rotate the mat for maximum wear and tear.

4' x 12'	ATS035	\$96.00
4' x 6'	AT6024	\$48.00
3' x 5'	AT6025	\$39.00
3' x 7'	AT6026	\$42.00
6' x 12'	AT6029	\$169.00
12' x 7'	AT6032	\$189.00
12' x 12'	AT6033	\$329.00



### (D) Bullpen Pitcher's Mat 12' X 12'

Made from durable turf with a 5 mm foam backing. Includes 2 throw-down home plates for your bullpen.

AT5030 - \$525.00

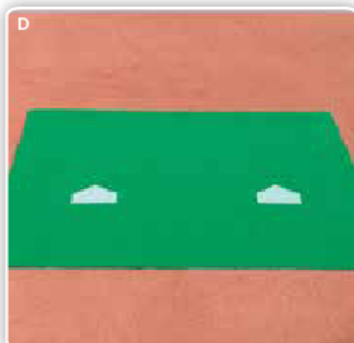

# Call for pricing on custom circles!



ON DECK CIRCLES



**Plain Green On Deck Circles**

Highest-quality turf available. Style and shade may vary.

4'	AT5026	\$179.00
5'	AT5032	\$219.00
6'	AT5004	\$249.00



Call for  
custom  
skirts!

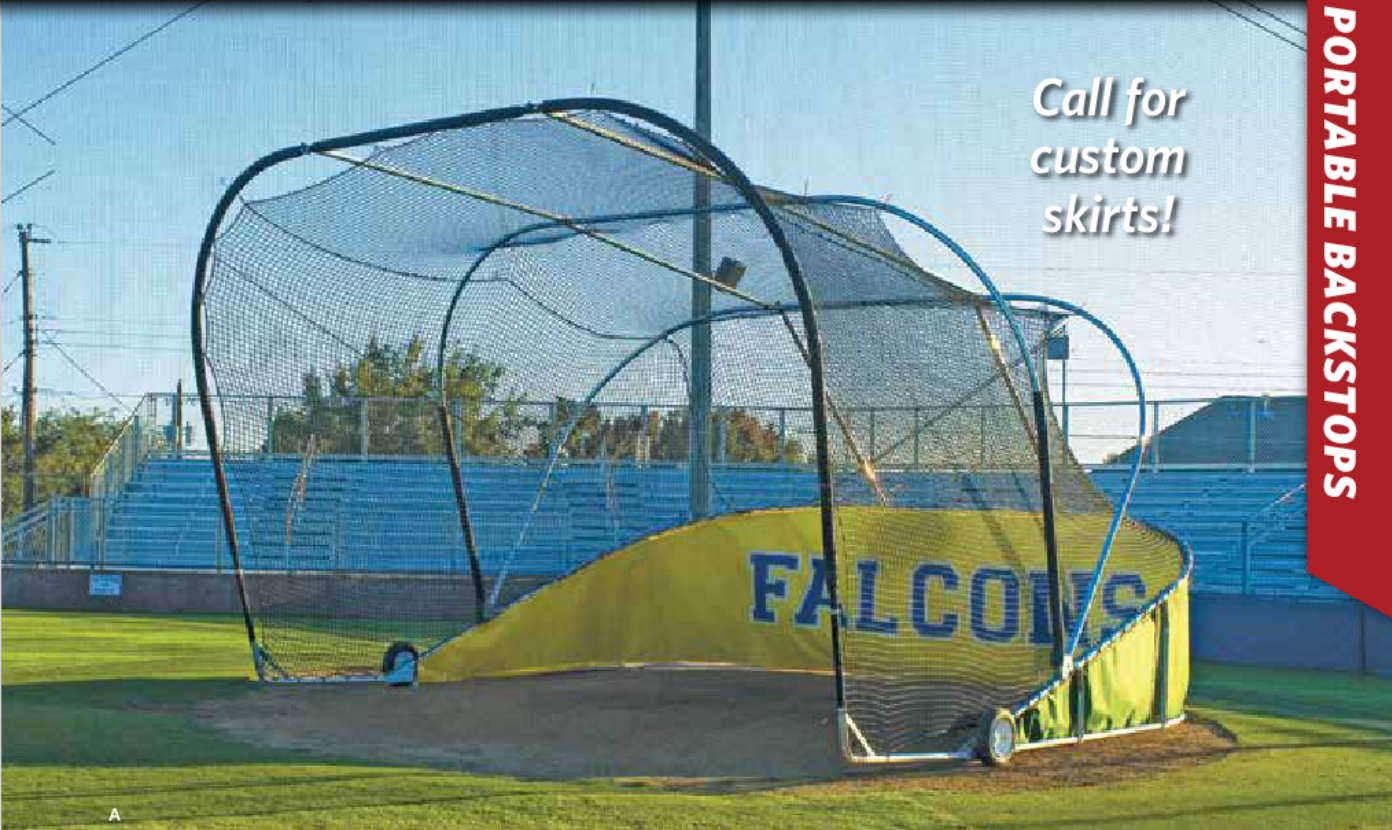

A

**(A) Big Bubba Portable Batting Cage Backstop**

Complete backstop includes batting cage, batting net, vinyl skirt and extra baffle netting behind batter. Collapses to just 5' high for simple storage. Batting cage backstop is built from thick aluminum tubing. Heavy-duty weather-treated #600 HTPP backstop netting. Vinyl-coated nylon bottom skirt. Double layer of netting behind batter. Quick lever and pneumatic wheels for moving the batting cage position. 42' of ricochet cushion around the backstop for reduced ball rebound. Elevated coach's observation bar for easy viewing. Measures 18'W x 22'D x 12'H. Batting cage skirts are available in green, navy, red or royal.

**Big Bubba Portable Batting Cage Backstop - \$4,499.99**

**(B) Big Bubba Elite Portable Backstop**

Ultimate portable batting cage for professional, collegiate and varsity ball-playing programs. Batting cage includes dual coach's observation platforms and collapses to only 5'H for easy storage. Pneumatic tires and dolly system for easy portability. Premium ricochet padding for most frame work. Heavy-duty 3.5mm weather-treated EHT netting w/extra 10' x 10' baffle net. Nylon-reinforced 18oz. vinyl skirt. Black thud pad w/grommets. Unit is constructed of thick aluminum tubing. Available in black, dark green, navy blue, red and royal blue.

**Bubba Elite Portable Baseball-Softball Backstop - \$4,999.99**

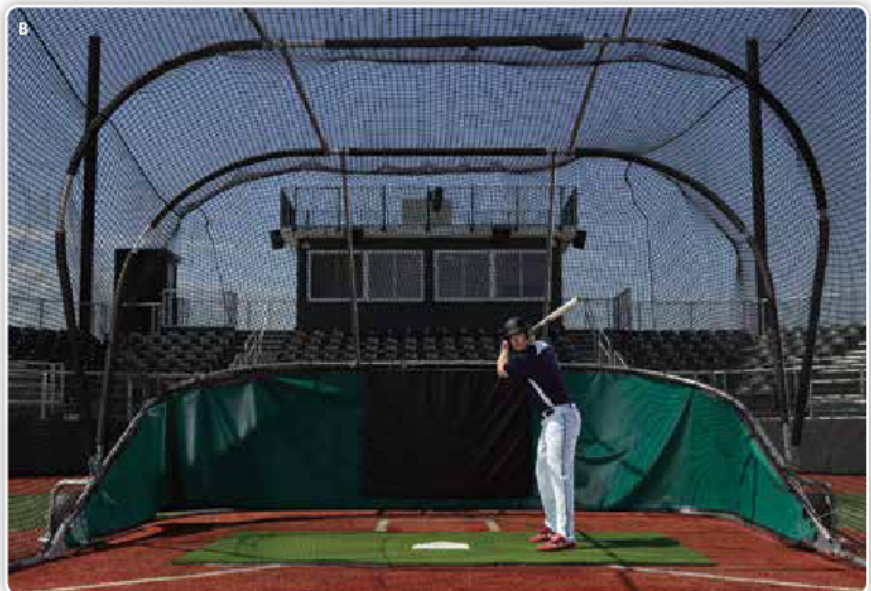

B



B



B

**CALL FOR PRICING ON CUSTOM LOGOS**



**Home Plate Halos**

All On Deck Sports home plate halos are made from the highest-grade turf available. Halos are pre-sized to fit 26' diameter home plate areas and are available in 5' or 10' wide, with or without shock pads and wings. The wings are designed to serve as pregame fungo circles. All of our logos are inlaid with colored turf. WE DO NOT PAINT LOGOS. Halos do require a concrete slab or asphalt base that should cure for at least 2 weeks before installation. Upon receiving approved artwork, halos typically ship within 2-3 weeks.

**Prices For Plain Green Halos**

	WITHOUT WINGS		WITH WINGS	
5' Home Plate Halo	AT6003	\$2,559.00	AT6002	\$2,999.00
5' Home Plate Halo and Shock Pad	AT6006	\$3,225.00	AT6005	\$3,925.00
10' Home Plate Halo	AT6001	\$3,750.00	AT6004	\$4,599.00
10' Home Plate Halo and Shock Pad	AT6008	\$5,679.00	AT6007	\$6,269.00

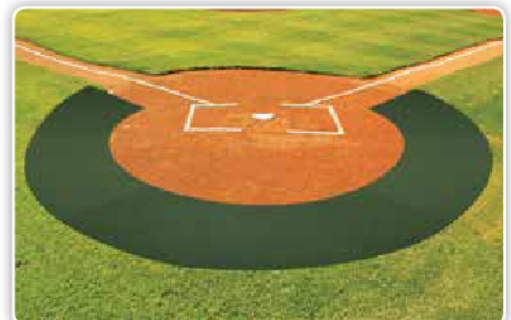





*Logos Are Inlaid Turf, Not Paint!*



Check out the step-by-step installation instructions at [blog.ondecksports.com](http://blog.ondecksports.com)

**(A) Batting Practice L-Screen Package**

Ideal for batting practice and hitting drills. Provides optimal protection for pitchers during batting practice. Padding and custom wheel kit is included. Designed for safety and durability. Protective screen is made with heavy-duty 1 5/8" galvanized welded steel, triple-coated for strength. Pitching screen includes #60 nylon pillowcase netting. L-screens are padded for added player safety and to protect the frame.

Screen	PS3010	\$499.00
Replacement Net	PS3015	\$135.00

**(B) Premium Series L-Screen**

The Premium Series L-Screen is made of 1 5/8" galvanized and powder-coated green piping, #36 twisted, knotted nylon netting, including a rope border and is hand-sewn at every mesh. Nets are a commercial-grade product. Padding helps to protect the life of the frame. The wheel kit allows the screen to be easily moved. This L-Screen has a 3' X 3' cutout, which offers more protection than the traditional 3.5' X 3.5' cutout. Excellent for hitting and pitching drill protection.

Screen	PS3003	\$239.00
Screen With Padding	PS3007	\$299.00
Replacement Net	SN6022	\$79.00
Wheel Kit	PS3006	\$49.00

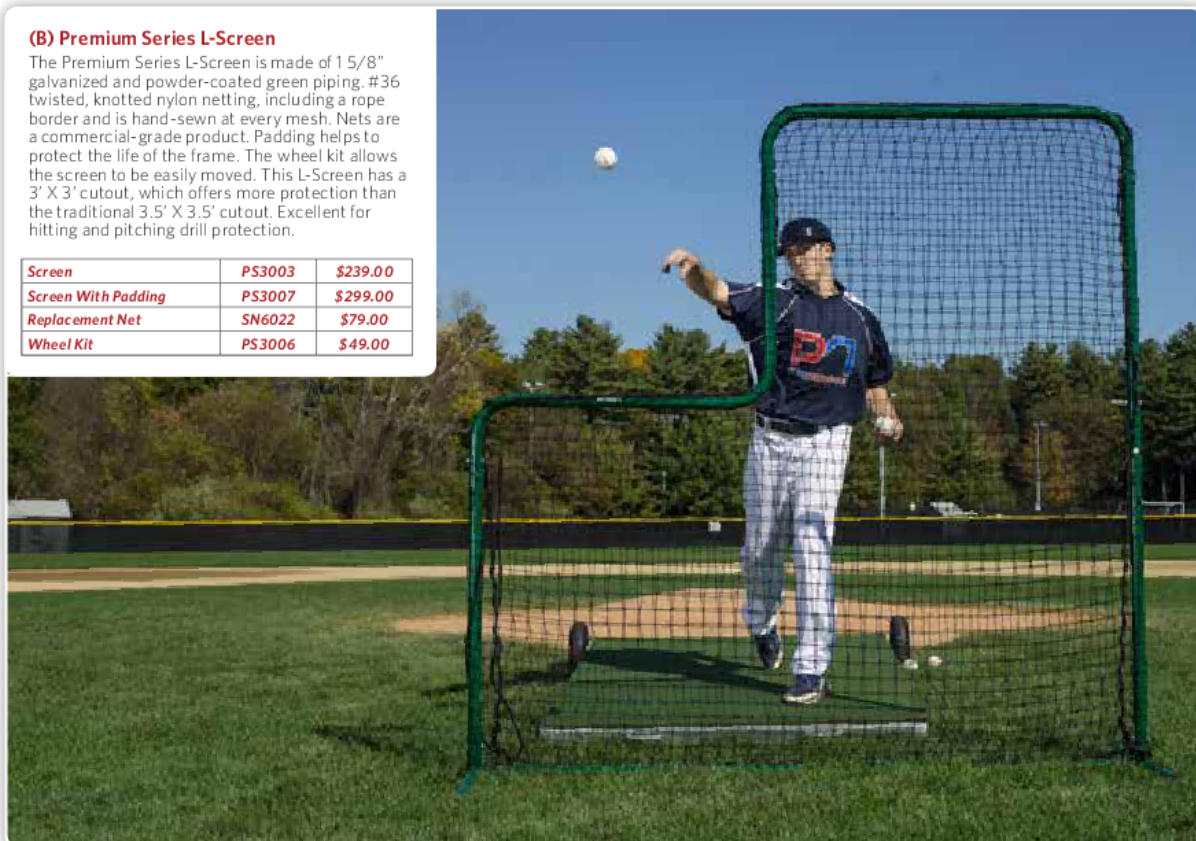



### Bullet L-Screen with Overhead Protection

Perfect for on and off field batting practice. The L-Shaped design with extra hip protection provides premiere coverage for the pitcher. This screen comes with an overhead protector to protect from balls landing on their head. No more having to wear a helmet while throwing BP in a tunnel. The overhead protector is reversible for left and right handed pitchers. See website for available colors.



### Bullet L-Screen Combo with Overhead Protection

Perfect for on and off field batting practice. The L-Shaped design with extra hip protection provides premiere coverage for the pitcher. This screen comes with an overhead protector to protect from balls landing on their head. No more having to wear a helmet while throwing BP in a tunnel. The overhead protector is reversible for left and right handed pitchers. See website for available colors.



Standard	PS3086-S	\$449.99
Padded	PS3086-P	\$499.99
Wheeled	PS3086-W	\$499.99
Padded w/ Wheels	PS3086-PW	\$549.99

Standard	PS3085-S	\$449.99
Padded	PS3085-P	\$499.99
Wheeled	PS3085-W	\$499.99
Padded w/ Wheels	PS3085-PW	\$549.99

### Easton Collapsible L-Screen

Fully portable pitching-hitting screen. For use with right-handed or left-handed baseball or softball pitchers. Breaks down easily in seconds to a 41" x 42" x 4" section for easy transport. This field screen provides excellent safety for batting practice. Constructed of durable two-sided weatherized polyester and a heavy-duty 7" x 7" steel frame.

PS3001 - \$249.99



### ATEC Portable Pitcher's L-Screen

Keep your players safe during on-field practice and training with a safety screen. This lightweight and portable protective L-screen fits in trunks of most cars. Excellent for hitting and pitching drill protection. Durable snap tubes for easy assembly. Includes heavy-duty carry bag.

PS3016 - \$199.99



### ATEC Pitcher's L-Screen

A must-have for any live batting on the field or in the cage use, use the L-Screen to throw batting practice with confidence. The L-Screen features 2-inch powder-coated tubing, a strong double-faced net and a diagonal vertical tube giving you the maximum protection.

PS3017 - \$299.99



### Pro Series Field Baseball-Softball L-Screen with Wheels

L-shaped design with extra diagonal hip protection in the corner. These protective field screens are constructed of heavy wall schedule 40 aluminum, 1.9" O.D. pipe. Complete with #60 (3mm) pillowcase-style weather-treated L-screen netting. Lacing only required at the bottom to close the protective net. The wheel kit includes large 10" x 4" pneumatic tires which allow the L-screen to be easily moved around baseball & softball fields.

PS3027 - \$615.99



### Safety 7' x 7' L-Screen

Safety 7' x 7' L-Screen is a reversible "L" shape for right or left handed pitchers. Durable 1.5", 18 gauge steel tube frame. 45-ply, envelope style P.E. net. Easy pushpin assembly. 37 lb. Not intended for use in a batting cage.

PS3061 - \$143.99



### Jugs Protector Series L-Screen

Jugs Protector Series L-Screen has black, pearl-foam, vinyl-covered .5" padding. Black, double-thick 691-90 ply, poly-E netting. Screens are easily assembled. All joints are double-bolted for maximum strength and superior longevity. 1.5" diameter, 2mm-thick, 1020 cold-rolled steel frame tubing. Two-year guarantee on netting and frame. Hitting facility tough design.

PS3067 - \$534.99



### Brute 7' x 7' L-Screen

Brute 7' x 7' L-Screen is a reversible "L" shape for right- or left-handed pitchers. Durable 1.5", 13.5 gauge steel tube frame. Extra strength 60-ply, envelope style P.E. net. Easy pushpin assembly. Ideal for use in a batting cage. 5-year frame guarantee; 2-year net guarantee.

PS3057 - \$186.99



**STANDARD AND CUSTOM REPLACEMENT L-SCREEN NETTING AVAILABLE**

Call a Sales Representative for more information



### (A) Premium 10' x 10' Field Screen

10' X 10' field screen is made of 1 5/8", galvanized and powder-coated green piping. Screen is easy to assemble. Perfect for hitting, pitching and fielding drill protection. #36 twisted, knotted nylon nets, with a rope border, and are hand-sewn at every mesh. Nets are a commercial-grade product. Optional wheel kit allows the protective screen to be easily moved around baseball & softball fields.

Screen	PS3012	\$359.00
Replacement Net	PS3014	\$145.00
Wheel Kit	PS3006	\$49.00



### (B) Premium 7' x 7' Field Screen

7' X 7' field screen is made of 1 5/8", galvanized and powder-coated green piping. Screen is easy to assemble. Perfect for hitting, pitching and fielding drill protection. #36 twisted, knotted nylon nets, with a rope border, and are hand-sewn at every mesh. Nets are a commercial-grade product. Optional wheel kit allows the protective screen to be easily moved around baseball & softball fields.

Screen	PS3002	\$239.00
Replacement Net	SN6021	\$79.00
Wheel Kit	PS3006	\$49.00



### (C) Premium Series Softball Screen

The Premium Series Softball Screen gives your pitchers the ultimate protection for a normal delivery. Pillowcase-style slip-on protective nets. Powder-coated green piping, #36 twisted, knotted nylon nets, include a rope border and are hand-sewn at every mesh. The softball screen nets are a durable, commercial-grade product. Optional wheel kit allows the softball screen to be moved easily (sold separately).

Screen	PS3005	\$239.00
Replacement Net	SN6024	\$99.00
Wheel Kit	PS3006	\$49.00



## (A) Bullet Hole Fastpitch Screen

The Bullet Fast Pitch screen is perfect for those coaches and players who like throwing through a pitch hole. Since all of our screens are American made in our warehouse we can customize the pitch hole to fit any coach's preference.

Standard	PS3087-S	\$349.99
Padded	PS3087-P	\$399.99
Wheeled	PS3087-W	\$399.99
Padded with Wheels	PS3087-PW	\$449.99



## (B) Bullet Front Toss Screen

The Bullet Front Toss Screen is commonly used for front toss or soft toss drills. The screen's narrow design makes it easy to maneuver inside smaller front toss hitting tunnels. The protective screen's cut out also allows for easy fast pitch batting practice.

Standard	PS3083-S	\$299.99
Padded	PS3083-P	\$349.99
Wheeled	PS3083-W	\$349.99
Padded with Wheels	PS3083-PW	\$399.99

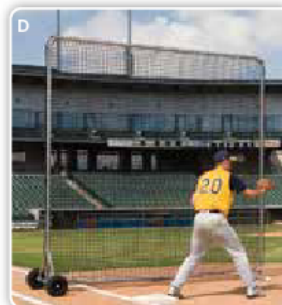
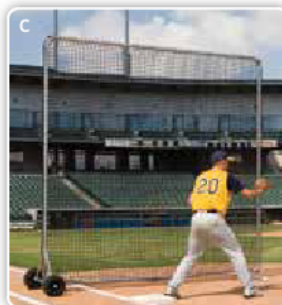

## (C) Pro Series 10'x10' Fungo Field Screen with wheels

Field screen frames are heavy wall schedule 40 aluminum pipe that is 1 5/8" diameter. Frame and wheel assemblies are welded for durability. Permanent 8" semi-pneumatic wheels for easy transport. Protective netting is #60 nylon weather-treated, 1 3/4" mesh. Protective netting is fabricated in pillow-case designs that slip over frames. Lacing is only required at the bottom to close the net. Weighs 54 lbs.

PS3023 - \$618.99

## (D) Pro Series 8'x8' Fungo Field Screen with wheels

On-field safety screen is perfect for pitching, batting and fielding drill protection. Protective netting is #60 nylon weather-treated, 1 3/4" mesh. Field screen frames are heavy wall schedule 40 aluminum pipe that is 1 5/8" diameter. Permanent 8" semi-pneumatic wheels for easy transport. Frame and wheel assemblies are welded for durability. Protective netting is fabricated in pillow case designs that slip over frames. Lacing is only required at the bottom to close the net.

PS3025 - \$555.99



## (E) Pro Series Tri-Fold Fungo 8'x16' Field Screen

Folding Baseball & Softball Field Screen is ideal for 2nd base and infield protection. Constructed of heavy wall schedule 40 aluminum 1.9" O.D. pipe. Main 8' x 8' screen with two 8' x 4' wings provides overall 8'H x 16'W protection. Field screen has side wings that easily collapse in for transport and storage. All slip-on double safety netting is #60 (3 mm) weather treated, 1 3/4" black mesh. 8" transport wheels are included.

PS3029 - \$880.99

## (F) Brute 7' x 7' Field Screen

Brute 7' x 7' field screen can be used during drills or as a portable backstop. Durable 1.5", 13.5 gauge steel tube frame. Extra-strength 60-ply, envelope style P.E. net. Easy pushpin assembly. Ideal for use in batting cage.

PS3051 - \$187.99



## (G) 7' x 7' Protective Field Screen

7' x 7' Protective Field Screen can be used during drills or as a portable backstop. Durable 1.5", 18 gauge steel tube frame. Extra-strength, 45-ply, envelope style P.E. net. Easy pushpin assembly. Not intended for batting cage use.

PS3055 - \$150.99

## (H) Jugs Protector Series Short Toss Screen

Black, pearl-foam, vinyl-covered .5-inch-thick padding. Black, double-thick 691-90 ply, poly-E netting. Screens are easily assembled — no welding or lacing. All joints are double-bolted for maximum strength and superior longevity. 1.5-inch-diameter, 2mm-thick, 1020 cold-rolled steel frame tubing. 2-Year guarantee on netting and frame. Hitting-facility tough design.

Dimensions: 7'H x 4'W.

PS3064 - \$534.99

PS3072 - Replacement Screen \$209.99

STANDARD AND CUSTOM  
REPLACEMENT FIELD NETTING  
AVAILABLE

Call a Sales Representative for more information

## CALL FOR CUSTOM LOGOS AND PRINTING



### Custom Windscreen

Most popular for baseball field fences and other outdoor sports. Note: Finished height of the material is actually an inch or two shorter as the windscreen should not reach the ground. Keeping the windscreen off the ground will limit the damage from lawnmowers and weed whackers. Grommets every 18 inches, Custom spacing for additional \$.03 per sq ft. Windscreens above 6' high come with horizontal lacing lip with grommets in center for stability. These screens can be printed on and customized if artwork is supplied. 2-yr. warranty.

**FECUSWS - Call For Pricing**



### Armor Mesh Windscreen

The most durable for baseball field fences and other outdoor sports. Armor mesh is tougher against abrasion, made with 40% more fabric weight. Keeping the windscreen off the ground will limit the damage from lawnmowers and weed whackers. Grommets every 18 inches, custom spacing for additional fee. Windscreens above 6' high come with horizontal lacing lip in center for stability. We suggest window flaps every 10 linear ft. Can be printed on and customized if artwork is supplied. Digital imaging can only be done up to 5' on this material. Heat-sealed border provides greater durability. 5-yr. warranty.

**Armor Mesh Windscreen - Call For Pricing**





## Colors Available

\*Colors may not be exactly as shown.

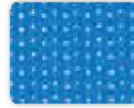

*Carolina Blue*

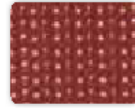

*Maroon*



*Dark Green*

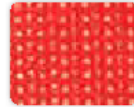

*Red*

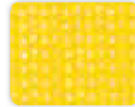

*Yellow*



*Purple*



*Royal Blue*

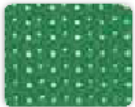

*Kelly Green*



*Orange*

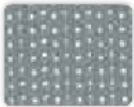

*Light Gray*

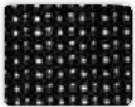

*Black*



*Navy*

**(A) Rectangular Window Box 6" H X 12" W**  
FE9997 - \$10.99



**(B) Half Moon Window Flap**  
18" wide.  
FE9998 - \$5.99

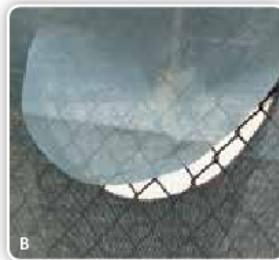

**(C) 8" Black Plastic Zip Ties**  
Pack of (100) 8" plastic zip ties.  
FE9999 - \$12.99

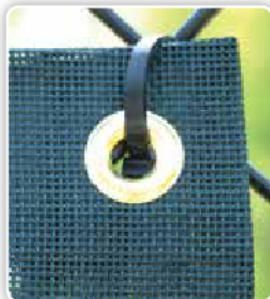



### Professional Series Spot Covers

18 oz. vinyl-coated poly with high UV protection. -40° cold crack. Heat-sealed waterproof seams. Customizable flag. Reinforced hem & spur grommets 24" apart. Weighted hem eliminates the need for stakes and grommets. USA made.

PREMIUM SERIES SPOT COVERS					
DESCRIPTION	SIZE	GROMMETED HEM		WEIGHTED HEM	
Base Cover Set	(3) 10'x10' Squares	FC6001	\$219.99	FC8001	\$639.99
Youth Pitcher's Mound	12' Circle	FC6006	\$129.99	FC8002	\$299.99
Youth Pitcher's Mound	18' Circle	FC6007	\$234.99	FC8003	\$479.99
Youth Home Plate Cover	20' Circle	FC6008	\$279.99	FC8004	\$559.99
Baseball/Softball Home Plate	26' Circle	FC6009	\$449.99	FC8005	\$799.99
Baseball/Softball Home Plate	30' Circle	FC6010	\$589.99	FC8006	\$969.99
Youth Field Kit	18' Circle, 12' Circle, (3) 10' x 10' Squares	FC6025	\$589.99	FC8091	\$1,349.99
Big League Field Kit	26' Circle, 18' Circle, (3) 10' x 10' Squares	FC6030	\$899.99	FC8092	\$1,829.99

### Lightweight Series Spot Covers

6 oz. vinyl-coated poly with high UV protection. 12 mil ultraviolet-resistant poly covers with rope-reinforced hem & spur grommets 24" apart. Sealed waterproof seams. Reinforced hem & spur grommets 24" apart. Weighted hem eliminates the need for stakes and grommets. USA made.

LIGHTWEIGHT SERIES SPOT COVERS					
DESCRIPTION	SIZE	GROMMETED HEM		WEIGHTED HEM	
Base Cover Set	(3) 10'x10' Squares	FC4001	\$159.99	FC8907	\$589.99
Base Cover	10' Circle	FC4005	\$69.99	FC8901	\$199.99
Youth Pitcher's Mound	12' Circle	FC4006	\$74.99	FC8903	\$254.99
Youth Pitcher's Mound	18' Circle	FC4007	\$119.99	FC8904	\$369.99
Youth Home Plate Cover	20' Circle	FC4008	\$139.99	FC8905	\$469.99
Baseball/Softball Home Plate	26' Circle	FC4009	\$215.99	FC8906	\$649.99
Baseball/Softball Home Plate	30' Circle	FC4010	\$289.99	FC8908	\$764.99
Youth Field Kit	18' Circle, 12' Circle, (3) 10' x 10' Squares	FC4011	\$369.99	FC8909	\$1,149.99
Big League Field Kit	26' Circle, 18' Circle, (3) 10' x 10' Squares	FC4002	\$499.99	FC8910	\$1,529.99



# FIELD COVERS

800.365.6171

FIELD COVERS



## Standard Series Spot Covers

8 oz. vinyl coated poly with high UV protection. Available in blue/white woven poly. Includes 2mm coating of Armorkote to improve tear and puncture resistance. Grommets every 3'-4'. Weighted hem eliminates the need for stakes and grommets.

STANDARD SERIES SPOT COVERS					
DESCRIPTION	SIZE	GROMMETED HEM		WEIGHTED HEM	
Base Cover Set	(3) 10'x10' Squares	FC9100-10x10	\$159.99	FC9101-10x10	\$589.99
Base Cover	10' Circle	FC9100-10	\$69.99	FC9101-10	\$199.99
Youth Pitcher's Mound	12' Circle	FC9100-12	\$75.99	FC9101-12	\$259.99
Youth Pitcher's Mound	18' Circle	FC9100-18	\$129.99	FC9101-18	\$389.99
Youth Home Plate Cover	20' Circle	FC9100-20	\$159.99	FC9101-20	\$469.99
Baseball/Softball Home Plate	26' Circle	FC9100-26	\$269.99	FC9101-26	\$649.99
Baseball/Softball Home Plate	30' Circle	FC9100-30	\$359.99	FC9101-30	\$759.99
Youth Field Kit	18' Circle, 12' Circle, (3) 10' x 10' Squares	FC9100-LL Kit	\$379.99	FC9101-LL Kit	\$1,169.99
Big League Field Kit	26' Circle, 18' Circle, (3) 10' x 10' Squares	FC9100-BL Kit	\$559.99	FC9101-BL Kit	\$1,539.99

## FIELD COVER SPECIFICATIONS

FABRIC TYPE	LIGHTWEIGHT 60Z POLY	STANDARD 80Z POLY	PREMIUM 180Z VINYL
COLORS	Silver/White, Silver/Black, White/White	Blue/White	Maple Green, Royal Blue, Red, Navy Blue, Gray, Maroon, Sky Blue, Purple, Yellow, White, Tan, Black, Kelly Green, Orange
TENSILE STRENGTH	215 x 180	255 x 250	275 x 230
TEAR STRENGTH	71 x 70	70 x 70	70 x 60
CUSTOM LOGOS	No	No	Yes

# PROTECT YOUR BASEBALL



**Custom printing available**

**(A) Full Field Covers**

All of our infield covers for baseball and softball fields are heat-sealed and hemmed. The covers are shipped in crates for ultimate shipping protection and are guaranteed with a full warranty against manufacturing defects. Handles are standard on all field covers. Each cover comes with stakes and a custom-fit UV-stabilized storage cover. Additional charge for cover lettering.

170' x 170' Light weight	FC9006	6 oz	\$5,359.99
160' x 160' Light weight	FC9007	6 oz	\$4,849.99
120' x 120' Lightweight	FC9008	6 oz	\$2,829.99
90' x 90' Lightweight	FC9009	6 oz	\$1,599.99
170' x 170' Standard	FC9014	8 oz	\$9,499.99
160' x 160' Standard	FC9015	8 oz	\$8,599.99
120' x 120' Standard	FC9016	8 oz	\$4,799.99
90' x 90' Standard	FC9017	8 oz	\$2,899.99
170' x 170' Pro-Grade	FC9010	10 oz	\$14,250.00
160' x 160' Pro-Grade	FC9011	10 oz	\$12,450.00
120' x 120' Pro-Grade	FC9012	10 oz	\$6,850.00
90' x 90' Pro-Grade	FC9013	10 oz	\$3,950.00

Custom sizes available; call 800.365.6171 for details

**(B) Winter Turf Blankets/Growth Covers**

Shields turf from wind, ice, snow and frost. Prevents unwanted foot and animal traffic. Promotes faster growth and greening in the spring. Warms the soil and air temperature. Allows light to pass through. Great for soccer, football, golf, baseball and all fields. 100% woven polypropylene. 6-ply, double-stitched hems. Brass spur grommets spaced 5' apart.

10' x 50'	FC0100	\$90.99
12' x 50'	FC0101	\$110.99
20' x 50'	FC0102	\$180.99
24' x 50'	FC0103	\$219.99
30' x 60'	FC0104	\$329.99
36' x 50'	FC0105	\$339.99
50' x 50'	FC0106	\$459.99
50' x 60'	FC0107	\$549.99
60' x 60'	FC0108	\$659.99
60' x 66'	FC0109	\$719.99
60' x 75'	FC0110	\$819.99
80' x 105'	FC0111	\$1,509.99
84' x 110'	FC0112	\$1,509.99
84' x 90'	FC0113	\$1,359.99
90' x 90'	FC0114	\$1,459.99
110' x 110'	FC0115	\$2,169.99

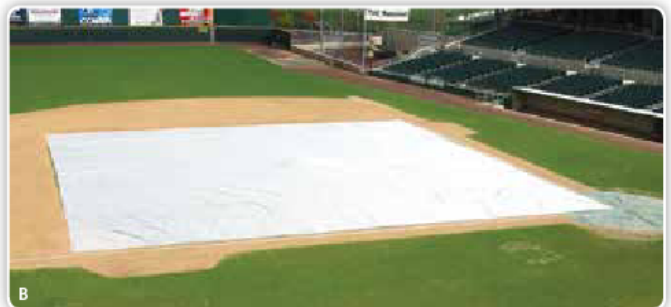
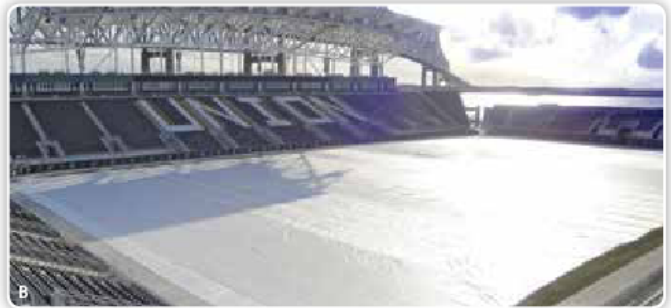



# ALL OR SOFTBALL FIELD

**FULL FIELD COVERS**



**(C) Storage Cover**

Collegiate covers available in Silver/White. Professional covers available in Black, Gray, Kelly Green, Maple Green, Maroon, Navy, Orange, Purple, Red, Royal Blue, Sky Blue, Tan, White, Yellow.

20' - Collegiate	FC1382	\$129.99
34' - Collegiate	FC1410	\$199.99
40' - Collegiate	FC1424	\$249.99
20' - Professional	FC1438	\$279.99
34' - Professional	FC1466	\$409.99
40' - Professional	FC1480	\$449.99

**(D) Field Cover Roller**

20' Roller	FC7144	\$709.99
34' Roller	FC7145	\$1,109.99
40' Roller	FC7146	\$1,319.99



# FIELD COVERS

FIELD COVERS



A

### (A) Trapezoid Infield Covers

For turf protection during batting practice. When your players aren't playing, they're practicing. And that can damage your field. Heavy-duty mesh covers protect your natural turf in front of the batting cage and other high-wear areas.

	STANDARD MESH		PREMIUM MESH	
25'D x 20'Wa x 70'Wb	FC7081	\$589.99	FC7086	\$819.99
20'D x 24'Wa x 64'Wb	FC7082	\$479.99	FC7087	\$639.99
20'D x 20'Wa x 60'Wb	FC7083	\$449.99	FC7088	\$579.99
15'D x 26'Wa x 56'Wb	FC7084	\$389.99	FC7089	\$509.99
15'D x 20'Wa x 50'Wb	FC7085	\$339.99	FC7090	\$469.99

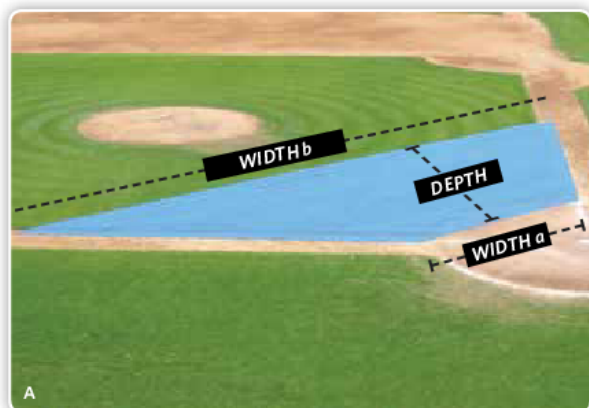

A

### (B) Bunt Zone Infield Protector/Trainer

Trainer saves turf and teaches by visualization. YELLOWS are bunt-for-a-hit target zones. GREENS are the sacrifice bunt target areas. RED is the bad bunt zone. Also teaches the area to avoid in hit-and-run or pull-hitting situations. A way to better protect the field, while also providing your team with a hitting and bunting trainer. The color patches are fusion-welded together to enable you to show your players where to bunt successfully. Tolerant of steel spikes and is virtually tear-proof. No need to set up cones for your bunting practice. Great for players at all ages and levels.

	MINOR LEAGUE		MAJOR LEAGUE	
20' x 24' x 64'	FC5018	\$679.99	FC5021	\$709.99
15' x 24' x 54'	FC5019	\$609.99	FC5022	\$639.99
15' x 18' x 48'	FC5020	\$559.99	FC5023	\$589.99



B





**(C) 2-Piece Cage Collar**

Protect your natural turf around the batting cage and other high-wear areas. Reinforced, grommet edges. 14 oz. ArmorMesh material is designed to withstand cleat traffic. Mesh is spike-resistant.

**FC7091 - \$999.99**



**(D) Installer Tube for Weighted Spot Covers**

The installer tube provides an easy way to roll up and store your weighted tarps. This installer tube allows two people to roll up the cover for the pitcher's mound, home plate or bullpen in less than 30 seconds. PVC pipe with aluminum reinforcement. 5' stainless steel cord (on each end) for pulling. Cords feature carry handles for comfort.



<b>12' Circle</b>	<b>FC6013</b>	<b>\$339.99</b>
<b>18' Circle</b>	<b>FC6014</b>	<b>\$419.99</b>
<b>20' Circle</b>	<b>FC6015</b>	<b>\$459.99</b>
<b>26' Circle</b>	<b>FC6016</b>	<b>\$519.99</b>
<b>30' Circle</b>	<b>FC6017</b>	<b>\$559.99</b>



**(E) Standard Sandbag**

Standard sandbag made for ensuring that tarp stays down through adverse weather conditions. Sand not included. Sold in sets of 25 bags.

**FC5000 - \$24.99**



**(F) Premium Sandbag**

Never worry about ripping sandbags again. Premium sandbags are constructed of heavy-duty nylon with handle, making it easy to carry on and off your field. Sold in sets of 25 bags.

**FC5001 - \$129.99**



Custom logos available

### Indoor Sports Facility Padding

Pole Pads, Gym Wall Padding, Wall Mats, Wall Pads and Protective Wall Padding: everyone calls them by a different name. On Deck Sports offers the widest variety of padding to meet your specific facility requirements. We have custom manufacturing capabilities to meet any need.

- Available in all shapes and sizes
- Constructed with 2" high-density foam
- Covered in 14-oz. vinyl
- Upgrades to 18 oz. and U.V.-resistant vinyl available



### Pole Padding

Velcro attachments for easy on/off • Custom-made to your specifications



*I-Beam Padding*

BEFORE



AFTER



*L-Shaped Padding*

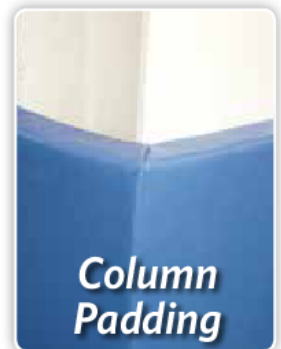

*Column Padding*



**NEW!**



**Starting  
at \$119.99  
per pad!**

### BACKSTOP PADDING

Backstop Padding with Grommets is available in 2', 3', 4' widths, in heights of 6', 8', 10', and 12' high. Call for custom options!



### CUSTOM GROMMETED RAIL PADDING

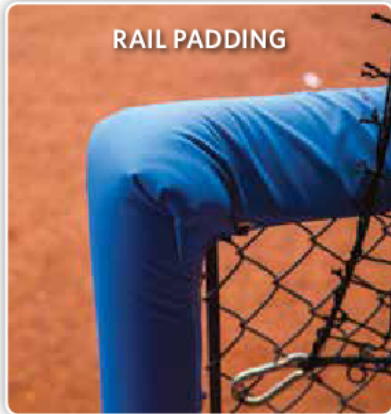

### RAIL PADDING



### WALL PADDING

### Colors Available

\*Colors may not be exactly as shown.



Forest Green   Navy   Red   Royal Blue   Gray   Maroon   Sky Blue   Purple   Yellow   White   Tan   Black   Kelly Green   Orange



### Complete Grand Slam Fencing Kit

Available in green, red or blue. Includes 3" yellow top home run marker and 18" ground auger to drill holes. Ground sockets recommended.

COMPLETE GRAND SLAM FENCING KIT				
ITEM	ROLL LENGTH	POLE SPACING	POLES	PRICE
200' Fence	314'	5'	65	\$1,099.99
200' Fence	314'	10'	33	\$859.99
300' Fence	471'	5'	86	\$1,499.99
300' Fence	471'	10'	49	\$1,139.99

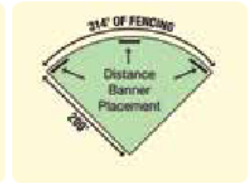

### Grand Slam Fencing Premium Kits

Grand Slam Fencing Premium Kits are the ideal way to define your outfield at any natural grass field. The kit is easy to set up and break down, and everything you need is included. Comes with 3" yellow top home run marker and is available in blue, green and red. Kit includes Foul pole kit, 3 Distance Banners, Tape Measure, and 18" Ground Auger as well as the fencing and poles detailed in the chart below.

GRAND SLAM PREMIUM FENCING KIT				
ITEM	ROLL LENGTH	POLE SPACING	POLES/GROUND SOCKETS	PRICE
200' Fence	314'	5'	65	\$1,699.99
200' Fence	314'	10'	33	\$1,399.99
300' Fence	471'	5'	86	\$2,199.99
300' Fence	471'	10'	49	\$1,699.99



### Grand Slam Fencing Standard Kits

Available in green, red or blue. Includes 3" of yellow top home run marker and auger to drill holes. Easier handling of smaller sections. Can design with overlap/gap in sections for ball retrieval. Can change the outfield distance by adding or eliminating sections. Ground sockets recommended.

GRAND SLAM FENCING STANDARD KIT			
ITEM	ROLL LENGTH	POLE	PRICE
FN1002	50'	6	\$159.99
FN1003	100'	11	\$259.99
FN1004	150'	16	\$349.99

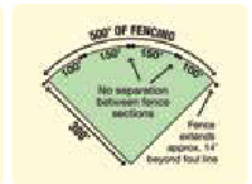
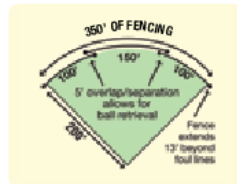

### Above-Ground Grand Slam Fencing

Portable fencing that can be used on any surface. No holes required! Durable and easy to transport. Lightweight and easy setup and breakdown. Available in red, blue and green with yellow top safety marker. Weighting for each pole to stand up to wind and prevent tipping. Attractive and cost-effective for crowd control or perimeter fencing.

50' Roll	FN1059	\$589.99
100' Roll	FN1060	\$949.99
150' Roll	FN1061	\$1,279.99
315' Roll	FN1062	\$2,299.99
471' Roll	FN1063	\$3,499.99



### Safety Top Cap

Simply snap over the top of the fence and lock the wire mesh with steel hog-rings (included in package) through the three pre-drilled holes on each piece. Manufactured using HDPE plastic and UV stabilizers. Designed to endure high impact, resist the harmful effects of the sun, and withstand severe weather conditions. Resists vandalism by using the hog-rings to permanently attach the Safety Top Cap to the fence. This product is growing in popularity at athletic fields, parks, playgrounds and recreational facilities throughout the country. Primarily used in safety yellow color for baseball fields. Bag contains five 8' pieces (40' per bag).



<b>Black</b>	<b>FE7137</b>	<b>\$129.99</b>
<b>Brown</b>	<b>FE7138</b>	<b>\$139.99</b>
<b>Green</b>	<b>FE7139</b>	<b>\$139.99</b>
<b>Red</b>	<b>FE7140</b>	<b>\$139.99</b>
<b>Royal Blue</b>	<b>FE7141</b>	<b>\$139.99</b>
<b>White</b>	<b>FE7142</b>	<b>\$139.99</b>
<b>Safety Yellow</b>	<b>FE7143</b>	<b>\$129.99</b>

### Fence Guard

Fence Guard has a professional teardrop shaped profile which is excellent for player protection and giving your field a professional look. Helps to reduce chain-link injuries by increasing visibility and hiding sharp edges. The 8' long sections and pre-drilled 24" holes make it easy to install for one person. The securing ties are included in the package. Lite standard, and premium are available in yellow, forest green, red and blue. The standard is also available in orange and white. Sold in 80' cartons. 5-year limited warranty.

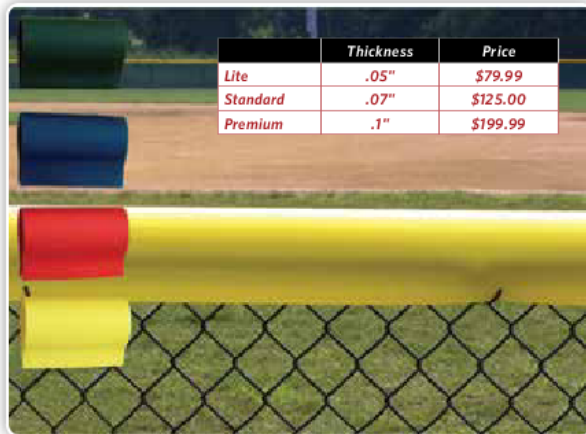

### PolyCap Fence Guard

PolyCap is an inexpensive way to beautify any field and to reduce player injury by increasing fence visibility. Weather-treated and UV-protected 4-1/2" diameter polyethylene construction will offer years of protection, backed by a limited 2-year warranty. Install with an optional tool and secure the cap with optional matching ties every three feet.

<b>100'</b>	<b>Yellow</b>	<b>FE7011</b>	<b>\$119.99</b>
<b>100'</b>	<b>Dark Green</b>	<b>FE7012</b>	<b>\$119.99</b>
<b>100'</b>	<b>Black</b>	<b>FE7077</b>	<b>\$119.99</b>
<b>100'</b>	<b>Bright Yellow</b>	<b>FE7080</b>	<b>\$109.99</b>
<b>250'</b>	<b>Yellow</b>	<b>FE7013</b>	<b>\$203.99</b>
<b>250'</b>	<b>Dark Green</b>	<b>FE7014</b>	<b>\$203.99</b>
<b>250'</b>	<b>Black</b>	<b>FE7078</b>	<b>\$189.99</b>
<b>250'</b>	<b>Bright Yellow</b>	<b>FE7081</b>	<b>\$189.99</b>



### PolyCap Installer Tool

FE7016 - \$34.99



### Fence Cap Ties

Contains 100 reusable ties per package. Each tie is 19" long. Ties come in black, yellow, dark green or bright yellow.

FE7018 - \$33.99



### Outfield Distance Markers

Outfield distance markers are printed digitally with 13 oz. reinforced vinyl fabric. Standard sizes are shown below. Banners are available in maple green, royal blue, red, navy blue, gray, maroon, sky blue, purple, yellow, white, tan, black, kelly green, and orange. Numerals are available in white, yellow, black, blue, red and athletic gold.

#### (A) Horizontal Outfield Distance Marker 27" x 36"

27"H x 36"W (14" numbers)  
FN7126 - \$75.99

#### (B) Horizontal Outfield Distance Marker 38" x 56"

38"H x 56"W (24" numbers)  
FN7127 - \$91.99

#### (C) Vertical Outfield Distance Marker

56"H x 20"W (12" numbers)  
FN7128 - \$81.99



### Smart Pole Ground Sockets

- Includes cap
- Ground Sockets have 1.66" OD

FN1007 - \$99.99  
FN1006 - \$179.99  
FN1005 - \$239.99



# BASEBALLS

BASEBALLS

## COLLEGE GAME BALLS

### Rawlings FSR1NCAA Flat Seam NCAA Official Baseballs

Rawlings FSR1NCAA Flat Seam NCAA Official Baseballs are sold by the dozen. Official ball of the NCAA Championships. Flat seam technology. Full-grain leather cover for added durability. Cushioned cork center.

BB2119 - \$93.99



### Diamond D1 Collegiate Baseball

The ultimate baseball with a cushioned cork center. White virgin wool winding. Ultra-premium full-grain leather cover. Low seam design. Sold by the dozen.

BB2196 - \$67.99



### Wilson A1001 Flat Seam Baseball

Wilson A1001 Flat Seam Baseballs are sold by the dozen. Red cushioned cork. Dura-core technology. Flat seam design. Grade A full-grain leather. Premium gray and white wool winding.

BB2126 - \$79.99



### Rawlings FSR100NAIA

Rawlings FSR100NAIA Baseballs are sold by the dozen. Official ball of the NAIA Championships. Flat seam technology. Full grain leather cover for added durability. Cushioned cork center.

BB2120 - \$93.99



### Diamond D1-PRO LS Low Seam Professional League Baseballs

Diamond D1-PRO LS Low Seam Professional League Baseballs sold by the dozen. Flat seam design. A-1 grade grey wool windings. Premium leather cover. Diamond Seam™. Good for pro and college play.

BB2122 - \$70.99



### Wilson A1010BPROFS Flat Seam College Baseballs

Wilson A1010BPROFS Flat Seam College Baseballs are sold by the dozen. Red cushioned cork with Dura-Core Technology. Grade-A full-grain leather. Flat seam baseball. Premium gray wool windings.

BB2127 - \$74.99



## HIGH SCHOOL GAME BALLS

### Rawlings FSR100HS Flat Seam

Rawlings FSR100HS Flat Seam High School Baseballs have a full-grain leather cover for added durability. Cushioned cork center. Core bond adhesive. Sold by the dozen.

BB2155 - \$79.99



### Diamond D1-HS High School Baseball

Diamond's most popular high school baseball. Cushioned cork center. Grey wool windings. Premium full-grain leather cover.

BB2217 - \$64.99



### Wilson A1010BHS Raised Seam Baseball

Sold by the dozen. Grade B full-grain leather. Super Seam Technology creates seams 20% higher than raised seam baseballs. Red cushioned cork core to energize the bat/ball collision. Added to the cork is the Dura-core technology which helps the ball retain hardness.

BB2039 - \$69.99



## COLLEGE / HIGH SCHOOL PRACTICE BALLS

### Wilson A1030B Raised Seam High School Practice Baseballs

Wilson A1030B Raised Seam High School Practice Baseballs are sold by the dozen. Comes with the On Deck Sports Ball bucket. Gray wool windings. Raised seams. Red cushioned cork center. Grade C full grain leather cover.

1 Dozen	BB0011	\$40.99
3 Dozen With Bucket	BB0098	\$119.99
5 Dozen With Bucket	BB0037	\$189.99



### Wilson A1030B Flat Seam High School Practice Baseballs

Wilson A1030B Flat Seam High School Practice Baseballs are sold by the dozen. Comes with the On Deck Sports Ball bucket. Gray wool windings. Flat seams. Red cushioned cork center. Grade C full grain leather cover.

1 Dozen	BB0011-FS	\$40.99
5 Dozen With Bucket	BB2128	\$199.99



### Rawlings ROLB1X Raised Seam Practice Baseballs

Rawlings ROLB1X Raised Seam Practice Baseballs have a full-grain leather cover for added durability. Cushioned cork center. Rawlings' raised seams for improved grip. Minor cosmetic imperfections. Perfect for practice.

1 Dozen	BB2055	\$41.99
3 Dozen With Bucket	BB0096	\$120.99
5 Dozen With Bucket	BB0097	\$190.99



FOR OUR FULL LINE OF BASEBALLS CHECK OUT ONDECKSPORTS.COM/BASEBALLS



## BABE RUTH/SENIOR LITTLE LEAGUE GAME BALLS

### Rawlings RBRO Baseball

Rawlings RBRO Raised Seam Babe Ruth Baseballs are sold by the dozen. Tournament grade baseball. Full-grain leather cover for added durability. Cushioned cork center. Rawlings' raised seam for improved grip.

**BB2077 - \$59.99**



### Diamond DBR Baseball

Diamond DBR Baseballs are sold by the dozen. Cushioned cork center. Yarn wound. Premium full grain leather cover. Babe Ruth Baseball.

**BB2132 - \$51.99**



### Wilson A1082 Baseball

Constructed with raised red seams to offer a superior grip, greater control and more accurate ball placement, the Wilson® Official Babe Ruth League Ball is player preferred and ready for action. A full grain leather cover and grey wool windings add durability and strength.

**BB2013 - \$49.99**



## YOUTH GAME BALLS

### Rawlings RLLB Baseballs

Rawlings RLLB Tournament Grade Little League Baseballs are sold by the dozen. Full-grain leather cover for added durability. Cushioned cork center. Rawlings' raised seam for improved grip. Rawlings RBRO Raised Seam Babe Ruth Baseballs are sold by the dozen. Tournament grade baseball. Full-grain leather cover for added durability. Cushioned cork center. Rawlings' raised seam for improved grip.

**BB2066 - \$59.99**



### Diamond DLL Baseball

Diamond DLL Little League Baseballs are tournament grade. Cushioned cork center. Yarn wound. Full-grain leather cover. Sold by the dozen.

**BB2168 - \$45.99**



### Wilson A1074BSST Little League Baseballs

Wilson A1074BSST Little League Baseballs have a grade C full grain leather cover. Raised seams for better control for pitchers and fielders. Red cushioned cork that keeps the ball more energized during bat/ball collision. Youth league game play. Sold by the dozen.

**BB2054 - \$49.99**



### Rawlings RCAL Official Cal Ripken Division Baseball

Rawlings RCAL Cal Ripken League Baseballs have a full-grain leather cover for added durability. Cushioned cork center. Rawlings raised seam for improved grip. Extra Innings Advanced Technology - lasts 15% longer with the same great consistency and moisture protection. Tournament-grade baseball.

**BB2063 - \$59.99**



### Diamond DLL1 Baseball

Diamond DLL1 Little League Baseballs are competition grade. Cork and rubber core. Yarn wound. Full-grain leather cover.

**BB2169 - \$38.99**



### Wilson A1078BCR1 Cal Ripken Baseballs

Wilson A1078BCR1 Cal Ripken Baseballs are sold by the dozen. Grade C full-grain leather cover. Raised seams for better control for pitchers and fielders. Red cushioned cork that keeps the ball more energized during bat/ball collision. Youth league game play.

**BB2070 - \$43.99**



## YOUTH PRACTICE BALLS

### Rawlings ROLBIX Raised Seam Practice Baseballs

Rawlings ROLBIX Raised Seam Practice Baseballs have a full-grain leather cover for added durability. Cushioned cork center. Rawlings' raised seams for improved grip. Minor cosmetic imperfections. Perfect for practice.

1 Dozen	BB2055	\$41.99
3 Dozen With Bucket	BB0096	\$120.99
5 Dozen With Bucket	BB0097	\$190.99



### Champro Youth Practice Baseballs

Official league baseball. Precision molded cushion cork core. Metered tension 5% wool yarn. Full grain leather cover. High school/youth practice ball.

1 Dozen	BB2204	\$32.99
5 Dozen With Bucket	BB0099	\$129.99



### Wilson A1060B Youth Practice Baseballs

Wilson A1060B Youth Practice Baseballs are sold by the dozen. Raised seams for better control for pitchers and fielders. Split leather cover. Cork and rubber center. Youth league game ball.

**BB2042 - \$39.99**



## INSTRUCTIONAL BALLS

### Rawlings Level Training Baseballs

Rawlings Level Training Baseballs are the official size/weight baseball. Polyurethane firm center that increases in firmness. Rawlings' pro-style seam. Sold by the dozen. Help your kids learn the game with these progressive training baseballs.

ITEM #	LEVEL	RECOMMENDED AGE	PRICE
BB2078	1	5-7	\$40.99
BB2166	5	7-10	\$38.99
BB2165	10	10 & Up	\$52.99



### Wilson A1217B Training Baseball

Wilson A1217B Training Baseballs are a soft compression baseball with a sponge center that creates a soft compression ball that makes youth play and indoor training more successful. 93% softer than traditional baseballs. Sold by the dozen.

BB2167 - \$32.99



### Wilson Soft Compression Baseball

Wilson Soft Compression Baseballs are sold by the dozen. A sponge center creates the soft compression. Level 1 soft compression is 93% softer and Level 5 is 85% softer than traditional baseballs. Raised seams for improved grip. Great for beginner level players.

BB2212 - Level 1 - \$37.99  
BB2213 - Level 5 - \$37.99



### Easton SoftStitch Incredi-Ball

The highest quality safety baseball available. Used as a learning tool by players and coaches at all levels of competition, including pro teams and top colleges. Reduced weight great for all practice drills, both indoors and out. Nylon ball with authentic baseball stitching.

BB1017 - \$45.99



### Easton Softtouch Incredi-Ball

Easton Softtouch Incredi-Ball 9" Baseballs utilize with younger players in order to make them comfortable with both ball handling and cut down on tentativeness. A unique safety core that limits flight and aids in reducing injuries. Polyurethane core and durable synthetic leather cover. Designed for indoor or outdoor use.

BB2073 - \$43.99



## PITCHING MACHINE BALLS

### Rawlings Leather Pitching Machine Baseball

The Rawlings Leather Pitching Machine Baseballs are designed for use in pitching machines. Durable, flat kevlar seams. Full-grain leather cover. Wound solid cork and rubber center. Sold by the dozen.

BB2146 - \$51.99



### Atec HI. Per Pro Leather Pitching Machine Baseballs

Atec HI. Per Pro Leather Pitching Machine Baseballs are sold by the dozen. Training machine approved. High tensile strength accu-seams. Premium full-grain leather. Red cushion cork center. Regulation weight & size. Aerodynamically optimized for pitching machines.

1 Dozen	BB2113	\$61.99
5 Dozen With Bucket	BB2129	\$294.99



### Diamond Leather Pitching Machine Baseballs

Diamond Leather Pitching Machine Baseballs are sold by the dozen. Machine batting practice baseball. Cork & rubber pill. A-grade grey wool blend winding. Premium leather cover. Diamond seam. Kevlar reinforced flat seam. Dual color stitching for easy identification.

BB2124 - \$52.99



### Pro Nine LPM9 Leather Pitching Machine Baseball

Pro Nine LPM9 Pitching Machine Baseball. Full-grain leather cover. Premium wool wound. Cork and rubber center. Flat seams for machine use. Special Kevlar stitching, stitches will not break! reacts like a game ball.

BB2110 - \$54.99



### Baden Ballistic Leather Pitching Machine Baseballs

Baden Ballistic Leather Pitching Machine Baseballs are sold by the dozen. Genuine leather pitching machine ball. Flat Kevlar seam. Dura cork/rubber core maintains its shape longer. Official size and weight.

1 Dozen	BB2092	\$53.99
5 Dozen With Bucket	BB2093	\$259.99



### Jugs Pearl Leather Pitching Machine Baseballs

Jugs Pearl Leather Pitching Machine Baseballs are sold by the dozen. Full-grain leather cover, cushion-corked center, wool winding. Lasts 5 times longer than any other brand of baseball (when used with machines). Regulation size and weight: 9 in./5 oz. Great for game or practice ball. 1-Year guarantee on NeverBreak™ Seam.

1 Dozen	BB0039	\$73.99
4 Dozen With Bucket	BB0036	\$288.99



FOR OUR FULL LINE OF BASEBALLS CHECK OUT ONDECKSPORTS.COM/BASEBALLS



## GAME BALLS

### Wilson ASA Fast Pitch Softballs

Wilson ASA Softballs. ASA approved. Optic yellow synthetic leather cover and super seam technology raised seams which are 20% higher than standard raised-seam softballs. Compression-controlled poly-core center. Meets ASA specifications and has a 375 lb. maximum compression rating.

BB2002	(11")	\$56.99
BB2002A	(12")	\$56.99



### Wilson ASA 12" A9106

Wilson ASA A9106 12" Softball. Yellow synthetic leather cover. Super Seam Technology, raised seam. Compression controlled cork center. Sold by the dozen.

BB2052A - \$48.99



### Wilson A9011 Softball

Wilson A9011 Softball 12" Softball. Compression-controlled polycore. NFHS approved. Super Seam. Frequency matched optic yellow leather. .47 COR. 375 LBS MAX.

BB2095 - \$77.99



### Rawlings Official NCAA Championship Game Ball

Rawlings Official NCAA Championship 12" fastpitch softballs have .47 C.O.R. and 400 lbs compression with red stitching and are approved for play in the NCAA. These Rawlings Dream Seam softballs have a raised seam with a high-density cork and pro leather cover that gives just the right amount of tack.

BB2103 - \$90.99



### Rawlings Pro Leather Red Dot ASA/NFHS

A step above competitors' 2-piece balls: that is why the best players in the nation choose Rawlings. The inner core uses Rawlings' proprietary dense cell formulation, creating a ball worthy of being the Official Championship Softball of the NCAA® and NAIA®. With the addition of the C-LOK™ adhesive and moisture barrier, the improved pro leather cover with just the right amount of tack, there is no wonder why Rawlings has a rich tradition in fastpitch.

BB2085A	(11")	\$72.99
BB2085	(12")	\$76.99



### Rawlings 12" Dream Seam USSSA Softball

Rawlings Official 12" fastpitch softballs have blue stitching and are approved for play in the USSSA. These Rawlings Dream Seam softballs have a raised seam with a high-density cork and pro leather cover.

BB2179 - \$71.99



### Wilson A9010 Collegiate 12" Softball

Compression Controlled Polycore is the most consistent playing softball in the world while providing unmatched durability. Leather cover. Optic yellow color. Super Seam Technology. .47 COR, 400lb. compression.

BB2084 - \$81.99



### Champro 12" NFHS Competition Fastpitch

Champro 12" NFHS Competition Fastpitch is NFHS approved. Solid polyurethane core. Optic yellow cover. .47 COR, 375 compression, red stitch. Raised seam.

BB2192 - \$50.49



### Champro 12" ASA Competition Fastpitch

Champro 12" ASA Competition Fastpitch has a solid polyurethane core. Optic yellow durahide cover. .47 COR, 375 compression, red stitch. Raised seam.

BB2193 - \$50.49



### Champro 11" ASA Competition Fastpitch

Champro 11" ASA Competition Fastpitch Softball has a solid polyurethane core. Optic yellow durahide cover. .47 COR, 375 compression, red stitch. Raised seam.

BB2194 - \$50.49



### Rawlings Dream Seam Softballs

For teams wanting the distinctive sound and feel of cork, Rawlings offers a complete line of NFHS, USSSA, NSA, and ISC cork game balls. Made of high-density cork and Worth's patented Dream Seam technology, they offer the performance you demand while giving a lower cost option game ball. COR .47. Cork Center. ASA/NFHS Approved. Optic yellow leather cover. Raised red stitching.

BB2088A	(11")	\$68.99
BB2088	(12")	\$68.99



### Rawlings Official NAIA Championship Softball NAIAFP

12" Official NAIA softball. .47 COR., and 400 lbs compression. Red stitch and raised seam.

BB2199 - \$90.99



## YOUTH

### Wilson A9075 Softball

Compression Controlled Polycore is the most consistent playing softball in the world while providing unmatched durability. Leather cover. Optic yellow color. Super Seam Technology. .47 COR, 375lb. compression.

BB1019 - \$69.99



### Wilson ASA 11"

Wilson ASA 11" softball. Optic yellow. Syntetic yellow with composite cork center.

BB2065 - \$49.99



### Wilson A92311" Softball

Wilson A9231 11" Softball. Red-stitched optic yellow softball. ASA stamped. Compression-controlled polycore center. SST seams. .47 COR/ Maximum 375 lbs. comp.

BB2071A - \$66.99



### Rawlings Little League Softballs

Rawlings Little League Softballs 11" - 12" Softball. ProTac cover. Yellow pro leather cover. Youth league softball. .47 COR, 375 lb. max compression. Poly-X Core.

BB2087	(11")	\$72.99
BB2087A	(12")	\$73.99



### Rawlings Babe Ruth Softballs

Size: 11" - 12". .47 COR, 375 lbs. 88 red stitch. Yellow cover. Poly X core.

BB2142	(11")	\$75.99
BB2142	(12")	\$75.99



### Wilson A9031 12" Softball

Wilson A9031 Softballs are sold by the dozen. Compression controlled polycore giving this softball unmatched durability. Optic yellow leather cover. Superstitch Seam Technology creating 20% higher seams for superior control by pitchers and fielders. .47 COR and 375 lb. Compression.

BB2071 - \$66.99



## PRACTICE & TRAINING

### (A) 12" Dimpled Yellow Softballs

12" Dimpled Yellow Softballs. Feel like a leather ball when hit. Won't damage bats or sting hands. Same size and weight of official softballs. Dimpled balls are specifically designed for pitching machines. Sold by the dozen.

BB0006 - \$30.99

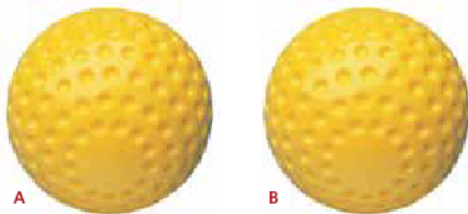

### (B) 11" Dimpled Yellow Softballs

11" Dimpled Yellow Softballs. Specially formulated with ink that will not rub off. Simulates the pitch of a real softball. Works in any pitching machine. Sold by the dozen.

BB0006A - \$30.99



### (C) Plastic Softballs

Set of 6 assorted colors. Great for soft toss. Improves hand-eye coordination. Softball size.

BB2010 - \$11.99



### (D) Plastic Wiffle Softballs

Practice ball. Great for tee work. Ideal for backyard games. Sold by the dozen.

BB2019B - \$13.99

### (E) Safety Softball

Made of PU sponge construction. Suitable for indoor/outdoor use.

BB2020 - \$26.99



## PRACTICE & TRAINING

### (A) Lightweight Softballs-WHT

Soft lightweight seamed pitching machine softball. Use with any pitching machine that throws standard-size baseballs. Maximizes speed of pitching machines. Sold by the dozen.

**BB0015 - \$34.99**

### (B) Jugs Lite Flite Softballs

Jugs Lite Flite Softballs are sold by the dozen. Throws true, even at regulation pitching distances. Designed specifically to be used in the Jugs Lite-Flite Machine. Keep their original shape coming out of the pitching machine, regardless of speed. Players see a realistic throw or pitch but do not get stung by the ball if it bounces off their arms or body. Ideal for offensive and defensive drills. Safe for indoor hitting without a batting cage.

BB2080	(11")	\$37.00
BB2081	(12")	\$37.00

### (C) Rawlings NCAA 11" Soft Training Ball

NC AA approved. 11 inch. Soft poly core. Synthetic cover. Red stitch color.

**BB2104 - \$48.99**

### Rawlings NCAA 12" RIF Training Ball

**BB2178 - \$48.99**

### (D) 12" Safety Softballs

Sold by the dozen. 12" Safety Softballs. Full grain leather. Yarn wound. Cushion cork yarn.

**BB2029 - \$39.99**

### (E) Seamed Dimpled Softballs 12"

12" Optic yellow seamed dimpled softball. Great for pitching machine use. Optic yellow color makes it easily visible. Sold by the dozen.

**BB0008 - \$44.99**

### (F) Baden All-Weather Softball

Baden All-weather Softball has a Composite CoreGuard™ optic yellow cover. Blue stitching. Remains playable even when wet. Returns to original weight after 24 hours drying time. Size: 12".

**BB0002 - \$51.99**

### (G) Wilson Soft Compression 12"

Wilson Soft Compression 12" Softballs have patented seam technology with 20% higher seams than other conventional balls. Gives pitchers superior control on the mound and helps fielders locate the ball faster in the glove and throw with better accuracy. Super seam technology. Optic yellow. Leather cover offers maximum brightness and residual tack.

**BB2051 - \$49.99**

### (H) Easton SofTouch IncrediBalls

Easton Sof Touch IncrediBalls 11" Neon Softballs are great for training use with children. They are slightly lighter than standard balls. Throw and catch is similar to the real thing. IncrediBalls feature a restricted flight design that makes them fly around 75% the distance of a real ball. They feature washable, durable covers for longevity. IncrediBalls offer a safer, sting-free experience on the field for youngsters. IncrediBalls can be used indoors or outdoors with a wide range of age groups.

BB2105	(11")	\$59.99
BB2074	(12")	\$64.99

### (I) Baden Ballistic Softball

Baden Ballistic Softball has genuine leather pitching machine softball. Flat Kevlar™ seams. Optic yellow. Dura-poly core maintains its shape longer. Size: 12".

**BB2135 - \$75.99**

### (J) Rawlings RIF Fastpitch Softballs

Rawlings RIF Fastpitch Softballs reduce wear and tear of ball impact. Enhances skill development. Reduces fear of ball impact due to lower compression specifications of the ball. Can lower team insurance rates. Does not change the game. Size 10" to 12". .47 COR. Yellow cover. 88 red stitch. Meets NOCSAE standards. ASA Certified.

ITEM #	SIZE	RIF (REDUCED IN JURY FACTOR)	PRICE
BB2086	10"	1	\$57.99
BB2086A	11"	1	\$57.99
BB2089	12"	10	\$57.99
BB2089A	11"	10	\$57.99

### (K) Easton SoftStitch IncrediBall Softball

Easton SoftStitch IncrediBall Softballs are used to teach the hitters to track the ball from release point to impact zone. Help the hitter improve depth perception by keeping head still and eyes level. Develop hand-eye coordination and a quick bat. Teach the fundamentals of hitting while removing the fear factor. Made with authentic baseball-style stitching and nylon cover.

**BB1018N - \$65.99**

### (L) Jugs Softie Softball

Jugs optic yellow softie softball. Official ball for Jugs Pitching Machine League games. Same size as regulation leather balls. Price per dozen.

BB2001A	(11")	\$66.99
BB2001	(12")	\$65.99

### (M) Weighted Training Softball Set

Set of 8 Weighted Training Softball Set. Improve pitching performance with weighted softballs. Same feel as a regular softball in graduated color-coded weights. Gradually increase the weight of the ball as your arm strengthens. Includes nylon carrying case.

**BB0010 - \$62.99**

### (N) ATEC HI. PER Pro Softball

Training machine approved. High tensile strength accu-seams. Premium full-grain Leather. Red cushion cork center. Regulation weight & size. Aerodynamically optimized for pitching machines. Indoor training.

BB2114	1 Dozen	\$94.99
BB2130	3 Dozen	\$269.99



A



B



C



D



E



F



G



H



I



J



K



L



M



N

# PV Tee™

Portable • Versatile • Tough

PV Tee™



ONE-YEAR MANUFACTURER'S WARRANTY



BEST OF SHOW



## “MEANT TO BE HIT”



Magnetic stem for easy breakdown

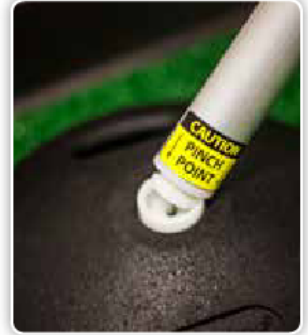

Flex pivot helps reduce wear and tear



Reinforced flexible rubber tee top

**(A) ProMounds PV Tee™**

Made from the highest quality materials, the PV Tee™ is designed to withstand the wear and tear of repetitive use. Utilizes a unique magnet to allow the tee to break down in one second and be put in an equipment bag for travel. Has a 10 lb weighted base that holds the tee in place and its flexible pivot joint allows the impact of a mis-hit to be realized in the pivot joint, not the other components. The flex pivot consists of a dual-spring design to return the stem to a ball ready position for the next swing. The PV Tee™ allows for continuous training by being virtually impossible to tip over. This tee was meant to be hit. One-year manufacturer's warranty. Dimensions: 27" - 47".

TA2401 - \$109.99

**(B) PV Tee™ Low-Stem**

Swing for the low corners and bottom of the strike zone. Non-pivot stem. Base included. Height: 20" - 26".

TA2400 - \$69.99



**(C) PV Tee™ Complete Package**

Includes: PV Tee™ Stem, PV Tee™ Low-Stem, and 1 Base.

TA2400-kit - \$149.99

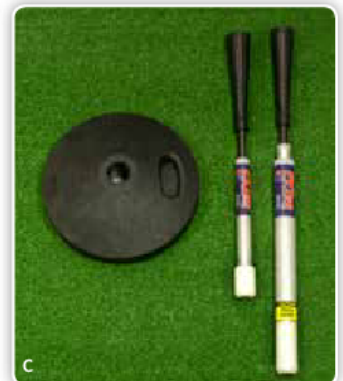



# PITCH WITH A PURPOSE™



## BEST OF SHOW

### The Designated Hitter™

Practice pitching any time with The Designated Hitter™. The DH allows pitchers of any age or skill level to get quality bullpen sessions without the need for a "live" batter. The batting dummy mimics a live batter, making bullpen sessions safer and more efficient. Great for baseball or softball players, The DH is safe to use with a catcher, due to beveled edges that reduce pitch deflections. Orange string marks the inside corner and provides a visual sight line, allowing your pitcher to improve pitching to the inside corner. Great for use in bullpens during games. Can act as both a left- or right-handed hitter. DH available in: blue, red, or gray.

5'9" DH Pro - \$329.00  
5'2" DH Youth - \$329.00

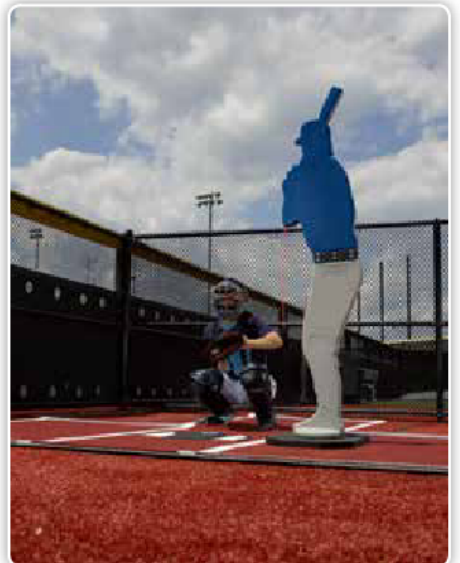



PATENT PENDING

**(A) Strike Strings Pitcher's Training Aid**

Strike Strings are a pitcher's training aid that provides strike zone visualization for pitchers with the advantage of immediate feedback. Constructed of high-visibility elastic strings to outline the strike zone. The only pitching target that offers a true "pitch through" to the catcher design. The flexible strings eliminate deflections for the catcher's safety and a true look at the pitch. Great for pitching practice and training pitchers of all ages. A versatile and durable design. Work the corners or three inches off the plate and anything in between. Easy set-up in minutes and attaches to almost anything.

Package	TA4000	\$39.99
Kit	TA4001	\$99.99

**(B) The Ultimate Pitcher's & Catcher's Plate**

The Ultimate Pitcher's and Catcher's Plate is an excellent training aid that emphasizes location. Uses high-visibility orange for the extended corners that are easy for the pitcher to see. Constructed of durable rubber. The extended corners increase the length of the plate 2.5" on each side. The back of the plate comes to three points to help with catcher positioning, centering themselves on each point to improve their ability to frame pitches.

TA2043A - \$24.99



A



B







### (A) Premium Series Sock Screen

Used for easily collecting batted and thrown balls. Ideal for baseball, softball fields, and other training facilities. Sock screen is made of 1 5/8" tubing, galvanized and powder-coated green. Commercial-grade sock screen nets are #36 twisted, knotted nylon. Sock screen design includes a rope border and are hand-sewn at every mesh. Twine included for tying off the bottom. Pillowcase-style slip-on sock nets. Optional wheel kit also available.

Screen	PS3004	\$279.00
Replacement Net	SN6023	\$105.00
Wheel Kit	PS3006	\$49.00

### (B) Jugs Protector Series Sock Screen

Jugs Protector Series Sock Net Screen has black, pearl-foam, vinyl-covered, .5-inch-thick padding. Black, double-thick 691-90 ply, poly-E netting. Screens are easily assembled—no welding or lacing. All joints are double-bolted for maximum strength and superior longevity. 1.5-inch-diameter, 2mm-thick, 1020 cold-rolled steel frame tubing. 2-year guarantee on netting and frame. Hitting-facility tough design.

PS3065 - \$534.99



### (C) Bownet Hitting Station & Mini Backstop

The Bownet Portable Hitting Station and Mini Backstop is a versatile portable sports net that's fantastic for baseball or softball play, from t-ball to college. This all-purpose hitting station works great for drills, practice and actual competition. Portable backstop is durable, yet lightweight. Simple to transport, set up, and move around the field.

TA2228 - \$299.99



### (D) Bownet Big Mouth Screen

The Bownet Big Mouth 7'x7' Sports Net is a portable sports net that works great for soft-toss, batting tee practice, and pitching practice. The key to the product design is the "bow" in the poles, which allows the poles to flex, and puts less stress on the net. Durable and portable. Quick set-up in about 90 seconds.

TA2226 - \$149.99





**(A) Pitcher's Pocket**

This training aid is perfect for evaluating a pitcher's accuracy. Available in 3 models 9, 12, 16 holes. The Pitcher's Pocket provides a complete variety of targets to improve and evaluate accuracy. Pitching frame is constructed of 1 5/8 in. steel. Pitching pocket has #60 gauge nylon netting laced to a 1/2 in. bungee cord. The frame is protected with vinyl-covered foam reinforced with grommets. Pitching frame sits on 2 removable legs. Great pitcher's target for baseball or softball practice. Feels like your own personal catcher instructing you exactly where to throw the pitch, and showing where it ends up. See website for available colors.

9-Hole	TA2021	\$249.99
12-Hole	TA3017	\$299.99
16-Hole	TA3115	\$349.99

**(B) Radar Pitching Trainer**

The Radar Pitching Trainer is the perfect pitcher's training solution from youth to pro. Works for baseball and softball. Combines a pitching target with a sonic radar speed indicator, virtual umpire, and pitch counter. Pitching radar keeps track of all pitching statistics. Includes a large balls and strikes display. Statistics are maintained for one or two players. Calculates ball speed from 20 to 99 mph (baseball or fastpitch softball). Ball speed is calculated from pitcher's release point. Pitching Radar can be set for Youth (45') or Adult (60' 6").

TA2114 - \$399.00



**(C) Rawlings Comeback and Pitching Target**

7/8" steel frame. Life-size catcher target for pitch training. Durable, easy-to-adjust elastic clips. Adjustable angle for fly balls or grounders. Easy assembly, no tools required. Includes pro drills and instructions.

TA2123 - \$63.99

**(D) The Pitching Pad**

The Pitching Pad is designed for pitching training and practice for players of all ages. The durable pad is made of thick durable vinyl, heavy duty straps with metal rings, and 4 inches of cushioning foam. Pitching training materials are included. Screen not included.

TA2172 - \$189.99



**(E) Easton Playback Elite**

With a unique patented hinge, the Playback Elite is a versatile training net that can be used for ground balls, line drives, and pop flies. Anytime and anywhere you want to practice, it is all you need to work on your footwork and fielding. Heavy-duty weatherized netting for ultimate playback response with durable rubberized net attachment bands. Speedy no-tool assembly.

TA2099 - \$109.99

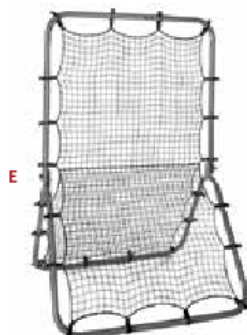



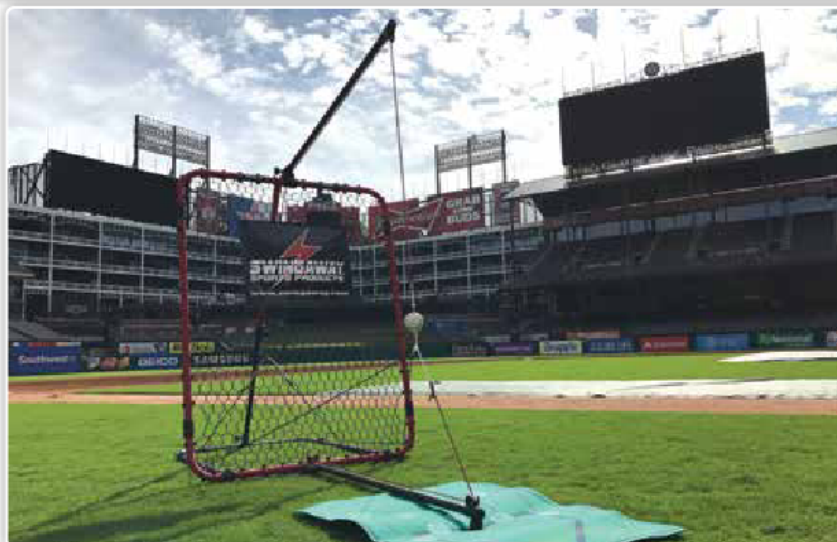

### SwingAway MVP Hitting Trainer

The SwingAway MVP Hitting Trainer allows varsity and youth players to train year-round on the most effective training station on the market. The SwingAway used to be limited to the pros, but the MVP is perfect for all players, regardless of level. Made with high-grade 17-gauge steel tubing, and has a durable 61" x 48" frame. Weighing only 38 lbs. This machine folds for easy, compact storage. Also includes a hitting mat and extra cords.

TA2252 - \$219.99

### XLP Training Net

The XLP Training Net is ideal for players or for a pitching/fielding target. It is designed to catch as many balls as possible with nearly the entire net being a catch pocket while using heavy-duty netting and double stitching to prevent against wear and tear. Sets up in less than a minute and fits easily into a travel bag for travel. Also includes ground stakes and a removable strike zone target.

TA2277	5' x 5'	\$119.99
TA2278	7' x 7'	\$149.99

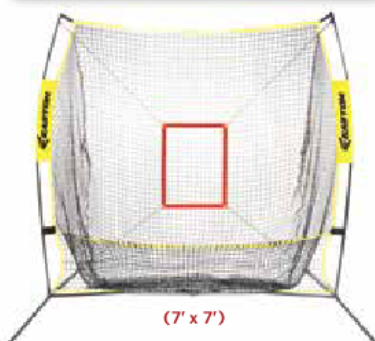

### SwingAway Pro-XXL

The SwingAway Pro-XXL is built with heavy-duty, 16-gauge industrial steel tubing, and weighs only 46 lbs. with a frame size of 67"H x 54"W. Comes with the patented SwingAway Hitting Mat and an upgraded institutional bungee and cord kit. Designed by former MLB players and coaches to meet the demands of professional teams and training facilities. The Pro-XXL is easy to assemble with most of the components pre-assembled. It is more of a stationary machine, but the base folds to the frame in seconds for maximum storability and portability.

TA2254 - \$329.99



### Bownet Elite Series Big Mouth

Bownet Elite Series Big Mouth is an 8' x 8' frame. This batting and pitching practice net is sure to become a favorite in the semi-pro and elite sports industry.

PS3075 - \$269.99



### Atec NI Portable Practice Net

Designed on an angle to eliminate ball rebound and collection time. Utilizes durable nylon netting with steel and fiberglass frame. Extremely stable in outdoor elements. Sets up in less than two minutes. Includes premium carry bag. Great for both hitting and pitching drills. One-year limited warranty.

TA2275 - \$149.95



### Instant Hit Net

Perfect to take on the road with you so that you can take batting practice wherever you are. Folds up in a small enough space to make it easy to store and carry; yet, when it opens, it is 8 feet in diameter. The lightweight spring steel folds down to a compact 36" circle when in the provided carry case, a heavy-duty nylon bag. Full-color instruction manual included. 1-year guarantee.

TA1019 - \$132.99





**(A) ProMounds PV Tee™**

Made from the highest quality materials, the PV Tee™ is designed to withstand the wear and tear of repetitive use. Utilizes a unique magnet to allow the tee to break down in one second and be put in an equipment bag for travel. Has a 10 lb weighted base that holds the tee in place and its flexible pivot joint allows the impact of a mis-hit to be realized in the pivot joint, not the other components. The flex pivot consists of a dual-spring design to return the stem to a ball-ready position for the next swing. The PV Tee™ allows for continuous training by being virtually impossible to tip over. This tee was "Meant to be Hit". One-year manufacturer's warranty. Dimensions: 27" - 47".

TA2401 - \$109.99

**(B) The G Tee**

Portable, easy set-up. The G-Tee is a unique batting tee. The base of the G-Tee is made of polyethylene and will not fade or warp. Its shape reduces catapulting and the weight post with the optional 10-lb weight plate gives it incredible stability. At the center of the base are a quick-change stabilizer and lock pin that securely hold the upright in place. Assembly or disassembly takes a matter of seconds.

26" - 53"	TA2180	\$109.99
22" - 41"	TA2190	\$105.99
10-lb G-Tee Weight	TA2191	\$19.99

**(C) 5-Point Hitting Tee**

Lightweight and breaks down for easy transport. This 5-point hitting tee is a great hitting aid, allowing for various placement of multiple balls. Perfect for baseball and softball. Comes with two fully adjustable extension tubes. Adjusts from 20" to 30".

TA1008 - \$49.99

**(G) Schutt Swing Rite Batting Tee**

Dual stems help hitting both inside and outside pitches. Folds into easy, compact 14" x 18 7/8" x 19" size with handle. Tees range from 21 3/4" up to 35 1/2" tall. Includes illustrated manual full of drills and exercises. 48-hole batting tee. This tee allows for regular and enlarged strike zones. The up/down adjustment teaches hitting the ball out front and not on top of the plate. Also helps eliminate the uppercut/golf type swing. Illustrated manual full of drills and exercises.

TA2051 - \$172.99

**(D) FallLine Single-Position Batting Tee**

10-year limited warranty. Constructed from a premium-grade polyurethane compound for ultimate durability, superior to similar rubber-based products. The base has a molded-in steel plate for extra weight to help keep the batting tee from tipping over.

TA1013 - \$69.99

**(H) Equi Tee Batting Tee**

Used by many Major League players, the Equi Tee is engineered to develop the hitter's swing to produce consistent solid contact and backspin that results in line drives. Proper practice with the Equi Tee will eliminate hitting problems caused by an uppercut swing. Made from solid rubber with specially engineered reinforcements to withstand the daily workouts of a professional hitter. Adjusts from 22" to 37" height for effective use by Major Leaguers or T-ball players.

TA2170 - \$79.99

**(E) FallLine Premium Baseball Batting Tee**

10-year limited warranty. The FallLine Premium Baseball Batting Tee is constructed from a premium-grade polyurethane compound for ultimate durability superior to similar rubber-based products. This tee is engineered to stand up to the toughest workouts. The heavy-duty construction of the Premium Tee includes a solid stem, thick-walled sleeve, and a base that is designed for maximum stability.

TA1012 - \$89.99

**(I) Deluxe Batting Tee**

Standard Little League batting tee. Mounted on an official rubber home plate, has a telescopic sleeve which adjusts from 22" to 47" to accommodate batters of all sizes. Replacement sleeves available, not included.

TA1010 - \$20.99

**(F) FallLine Multi-Position Batting Tee**

Constructed from a premium-grade polyurethane compound for ultimate durability superior to similar rubber-based products. Includes 2 adjustable posts and offers 5 post locations for a variety of training exercises. The base is designed for stability in order to help reduce the batting tee from tipping over. 10-year limited warranty.

TA1011 - \$89.99

**(J) Schutt Ultimate Travel Tee**

For use at all levels of play. Telescopes from 27" to 57". Top rubber tip folds over on impact while tee remains upright. Single base included with product. Baseball and softball top tubes included with purchase. Can be carried easily in travel bag or personal bag. Interchangeable with Swing Rite Tee. Durable construction for longer life. Excellent for camps and clinics.

TA2038 - \$30.99





### Batting Practice Ball Cart

The more time a player spends working on his/her swing the better, and this Batting Practice Ball Cart can be filled with a good workout's worth of at-bats. Made of heavy duty 1.5" O.D. powder-coated steel, this large capacity basket measures 16"H x 20"W x 25"L and is able to hold hundreds of balls. Oversize no-flat tires allow it to effortlessly roll over gym floors and grass alike. Load up the Batting Practice Ball Cart and get your team to improve their batting stats.

TA2178A - \$204.99



### The "Original" Ball Caddy

Holds 200 balls. No assembly required. Ships easily in one piece. Available in gray, navy and royal blue.

TA2147 - \$399.99

Colors - \$499.99



### Schutt BP Barrel

The Schutt BP Barrel is portable and easy to use. Has internal wire frame shelf that is spring loaded and raises and lowers with the weight of the balls. Secure and waterproof lid to keep out the rain and baseballs inside.

TA2293 - \$249.99



### Weighted Total Control Balls

The weighted TCB balls are used for optimum resistance to develop the muscles, both slow and fast pitch. Develop strength and drive through the hitting zone. Safe for all bats. Long-lasting and washable.

7.4 oz	12-Pack	TA2248	\$79.99
8.2 oz	12-Pack	TA2250	\$79.99
7.4 oz	6-Pack	TA2247	\$39.99
8.2 oz	6-Pack	TA2249	\$39.99



### Atomic Total Control Ball

A pure strength development hitting aid for the core and upper body. Has a 4.7" diameter and weighs 900 grams. Can be used for both softball and baseball. To be used for side toss or tee work only. With its heavy weighted design start out with 3-6 hits and increase to a maximum of 12 hits per training session.

12-Pack	TA2269	\$129.99
6-Pack	TA2270	\$69.99
3-Pack	TA2271	\$38.99



### Total Control Hole Ball

The only wiffle-style ball designed to last. Made from the same base material as the TCB Ball and guaranteed for 1 full year from any breakage. Hits better, throws better with the same flight as ordinary plastic balls. The ultimate replacement of hard plastic wiffle balls. The optimum use is when the front toss method is used.

Hole Ball 50	48-Pack	TA2262	\$99.99
Hole Ball 74	48-Pack	TA2265	\$149.99
Hole Ball 80	48-Pack	TA2268	\$149.99



### Rawlings Great Hands

Durable leather construction. Flat trainer that can be used like a real glove. Smaller size and shape is great for improving your fielding. Fits youth and adult hands. No-pocket design. Includes pro drills and instructions.

TA2162 - \$28.99



### Akadema Pancake Glove

30" circumference pancake glove. Designed to help teach fielding fundamentals. Features a near-flat design that forces players to use two hands. Available for right- or left-handed players.

Right Hand Throw - TA2050 - \$54.99  
Left Hand Throw - TA2050A - \$54.99



### Rawlings Foam Quick Hands Trainer

Constructed of a high-durability foam for lasting performance that is contoured to fit palm. A great fielding aid for all ages. Teaches proper fielding techniques and allows player to learn to get rid of the ball quickly.

TA2127 - \$10.99



### Schutt Slide-Rite 2.0

Teaches sliding and diving skills for all sports. Sliding pad is durable Cordura® with open-cell foam cushion inside mat. Each model is 3 1/2" thick. Sliding sheet on top is made of canvas. Can be used for all types of slides.

TA2034A - 285.99

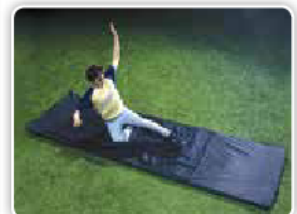

# PITCHING AIDS

PITCHING AIDS

### Stalker Pro II Radar Gun

The versatile Stalker Pro II is the choice of Major League Baseball and top-level collegiate and Semi-Pro teams worldwide. The Pro II quickly and accurately measures the speed of anything moving through the air, over land, or on the water. The one sports radar that does it all! Baseball Mode - 500 Foot Range! Rechargeable Li-Ion battery handle. Hard plastic carrying case.

TA2056 - \$1199.00



### Jugs Pro-Sports Radar Gun

Comes with Digital Signal Processing (DSP) state-of-the-art technology and is fully guaranteed for an industry-best two years. Guaranteed to have an accuracy index of  $\pm 0.5$  mph. Measures both MPH and KPH. Speed Range: 5-140 mph (8-224 kph). Greater distance range—up to 300 ft.

TA2117 - \$1099.99



### Ball Coach Pocket Radar

The Ball Coach™ is specifically designed to measure the fastest speed of a ball in flight. Measures from 25-130mph at a range of 120'. Includes: belt holster case, wrist strap, 2 AAA batteries, quick-start guide and a 2-year warranty. Easy trigger capabilities eliminate any timing requirements: Simply hold the button down well before the ball is in flight and release once the speed is displayed. Enter Constant-On Mode to provide automatic triggering without the press of a button.

TA2285 - \$299.99



### Stalker Sport II Radar Gun

Capture accurate pitch speeds - EVERY TIME! 300 foot range - Stalker guns outperform all others! Built to last - just ask any baseball scout. Accurate to +/- 3% of reading. Measure speeds from 5-150 MPH.

TA2053A Starter Package - \$499.00

TA2053B Scout Package with Rechargeable Batteries - \$549.00

TA2053 Deluxe Package with Hard Case and Rechargeable Batteries - \$599.99



### Pitcher's Power Drive

The Pitcher's Power Drive teaches pitchers to use a proper weight transfer through their leg kick and back hip, pushing their front hip in front of their lead shoulder to create the power drive. The device teaches by a combination of auditory sound and kinetic feel. The timing click trains pitchers to initiate power with their back hip to keep their weight over the rubber longer. Keeping the weight back longer creates a more explosive landing through the hip and torso. Teaching pitchers to use their lower body to throw will increase their velocity and power.

Professional / Collegiate Metal	TA2118	\$205.00
Professional / Collegiate Clay Turf	TA2118CT	\$245.00
Professional / Collegiate Green Turf	TA2118T	\$245.00
Youth Metal	TA2168	\$179.00
Youth Clay Turf	TA2168T	\$215.00
Youth Green Turf	TA2171	\$215.00

### Softball Power Drive

Teaches softball pitchers to use their legs more effectively by linking up the timing from initial foot push with the proper body posture angle to be a softball power pitcher. All great athletes use their lower-body power to maximize the kinetic chain to create explosive power. The Softball Power Drive maximizes the push of the softball pitcher's foot as the starting point through the leg drive and body to fingertips which is the final link of the kinetic chain. There are two Softball Power Drive models available, made in the USA of solid steel weighing 14 lbs. They are built to handle the extreme use of softball teams and softball academies. Durable and long lasting. The two models are: Collegiate / Pro Turf Model - for use with cleats or turf shoes. Collegiate / Pro Metal Model - for use with tennis or turf shoes.

Metal	TA2176	\$205.00
Turf	TA2177	\$245.00



PITCHERS POWER DRIVE





## ADULT HELMETS

### Rawlings 90 MPH Clear Coat Helmet

Meets NOCANE® standard up to 90 miles-per-hour baseball pitch speed. Enhanced ABS plastic shell stiffness for optimal performance. Features Heat Exchange™ venting technology. Dual-density foam liner for maximum impact absorption and optimal comfort. Clear-coat paint finish. Sizes S (6 7/8" - 7"), M (7 1/8" - 7 1/4"), L (7 3/8" - 7 1/2"), XL (7 5/8" - 7 3/4").

**BH9092 - \$69.99**



### Rawlings Mach Two-Tone Helmet

New MACH shell design provides sleeker profile with optimized ventilation. IMPAX high performance padding absorbs and dispenses force forming a barrier for the ultimate protection. Attached EXT flap gives high visibility and additional facial coverage. TPU rubber piece concealing hardware for seamless design. Available in Senior: 6 7/8" - 7 5/8" Junior: 6 3/8" - 7 1/8".

**BH9196 - \$77.99**



### Demarini Paradox Fitted Pro Batting Helmet

The Demarini Paradox Fitted Pro Batting Helmet has dual density padding that is fitted to your specific size for the perfect fit. Comes with a premium rubberized matte finish. Also features a strategic venting system keeps your head cool. Low profile shell for superior fit.

**BH9147 - \$39.99**



### Rawlings CFABHN Batting Helmet

Meets NOCSAE standards. 16-vent design featuring exclusive COOLFLO® XV1 style venting. Heat Exchange™ vents rapidly circulate cooler, ambient air. Wrapped jawpads for improved comfort/fit. Clear coat paint finish. Sizes: S (6 7/8" - 7"), M (7 1/8" - 7 1/4"), L (7 3/8" - 7 1/2"), XL (7 5/8" - 7 3/4").

**BH9006 - \$36.99**



### Rawlings R16S/J

With its eye-catching finish and ultra-cushioned fit, the new Rawlings Velo™ series perfectly blends style and comfort. The Velo™ series has been constructed with 16 individual vents for optimal air flow and circulation allowing its wearer to stay cool and dry. The Velo™ is ideal for the athlete that wants to flash some personality at the plate. Available in Senior: 6 7/8" - 7 5/8" Junior: 6 3/8" - 7 1/8".

**BH9194 - \$36.99**



### Easton Pro X™ Batting Helmet

MDP Multi-Density protection with 3 layers of impact absorbing density foam. BioDri(TM) liner fabric with wrapped air mesh side walls for moisture management. Matte finish with tonal metallic accents. ABS thermoplastic shell engineered for maximum protection. Extended Jaw Guard mounted to pro X helmet offers extra protection on the side of the helmet facing the pitcher. Meets NOCSAE standard for all levels of play.

**BH9191-Junior - \$59.99**

**BH9192-Adult - \$59.99**

**BH9199-Jaw Guard Attachment - \$19.99**



### Easton Z5 Grip Batting Helmet

Easton Z5 Grip Matte Batting Helmet has a high-impact-resistant ABS shell for maximum protection. Dual-density foam liner for shock absorption and comfort. BioDri™ padded inner liner absorbs sweat. Wrapped ear pads for durability and comfort. Junior (6 3/8" - 7 1/8"), Senior (6 7/8" - 7 5/8").

**BH9129 - \$39.99**



### Easton Z5 Solid Batting Helmet

Easton Z5 Grip Solid Batting Helmet has a high-impact-resistant ABS shell for maximum protection. Dual-density foam liner for shock absorption and comfort. BioDri™ padded inner liner absorbs sweat. Wrapped ear pads for durability and comfort. Junior (6 3/8" - 7 1/8"), Senior (6 7/8" - 7 5/8").

**BH9130 - \$24.99**



### Easton Z5 2.0 Matte Two-Tone Helmet

High impact resistant ABS shell for maximum protection. Dual-density foam liner for shock absorption and comfort. BioDri™ padded inner liner absorbs moisture. Wrapped ear pads for durability and comfort. Available in XL: 7 1/2" - 8", Senior: 6 7/8" - 7 5/8", JUNIOR: 6 3/8" - 7 1/8".

**BH9190-Adult - \$39.99**

**BH9191-Junior - \$39.99**



## COACHES HELMETS

**Rawlings COOLFLO Base Coach Helmet**

Official base coach helmet of Major League Baseball. High-impact shell features premium ABS with a durable clear-coat paint job for protection and durability while coaching the bases. Comes standard with pro padding and covered headband for comfort. Coach helmet comes with no earflap design. Exclusive COOLFLO® venting technology. Sizes: (6 7/8", 7 1/8", 7 1/4", 7 3/8", 7 1/2", 7 5/8").

BH9019 - \$25.99

**Rawlings Matte Base Coach Helmet**

COOLFLO® design. ABS plastic shell construction with a covered headband for increased comfort. Matte finish. Sizing: S (6 7/8" - 7"), M (7 1/8" - 7 1/4"), L (7 3/8" - 7 1/2"), XL (7 5/8" - 8").

BH9108 - \$31.99

**Easton CCX Grip Cap**

Easton CCX Grip Cap has a high-impact-resistant ABS plastic, providing an excellent protective shell. Dual-density foam absorbs and provides comfort. BioDri™ liner absorbs sweat and pulls it away from your head.

S/M (6 7/8" - 7 1/4"), LG/XL (7 1/4" - 7 5/8").

BH9138-L/XL - \$29.99

BH9139-S/M - \$29.99



## YOUTH HELMETS

**Rawlings Youth Coolflo Batting Helmet**

Meets NOCSAE standards. Traditional COOLFLO design. Pre-drilled for Rawlings NOCSAE-approved face guards. Molded finish. Size: (6 1/2" - 7 1/2").

BH9001 - \$19.99

**Easton Z5 Solid with Face Guard**

Easton Z5 Solid Batting Helmet has a high-impact-resistant ABS shell for maximum protection. Dual-density foam liner for shock absorption and comfort. BioDri™ padded inner liner absorbs sweat. Ponytail channel for added comfort. Wrapped ear pads for durability and comfort. Junior (6 3/8" - 7 1/8").

BH9137 - \$35.99

**Rawlings Coolflo T-Ball**

Coolflo venting technology. Dual-density foam for protection and comfortable fit. Pre-drilled for NOCSAE®-approved ABCRWG face guard. Includes snaps for use with RCS chin strap. Meets NOCSAE® standards. Size: (6 1/4" to 6 7/8").

BH9014 - \$19.99

**Easton Natural Teeball with Face Mask**

Easton Natural Tee-Ball Batting Helmet has a high-impact-resistant ABS shell for maximum protection. Dual-density foam liner for shock absorption and comfort. BioDri padded inner liner absorbs sweat. Wrapped ear pads for durability and comfort. Comes with a face mask good for baseball and softball. Size: (6" - 6 1/2").

BH9146 - \$34.99

**Coolflo Batting Helmet with Cage**

Approved for all baseball and softball leagues. Attached face mask includes new wire configuration for greater visibility. High-impact ABS plastic shell with painted metallic finish. Double-ear design. Includes separate cup chin strap that snaps onto helmet. Utilizes Coolflo venting technology and 15 individual vents for outstanding airflow. ProDri interior padding provides cushion and prevents the growth of odor-causing bacteria. Batting helmet meets NOCSAE® standards. One-size helmet. Fits hat sizes (6 1/2" - 7 1/2").

BH9023 - \$30.99



SEE OUR  
FULL LINE OF  
HELMETS AT  
ONDECKSPORTS.COM



## SOFTBALL HELMETS

### Demarini Paradox Fitted Pro Batting Helmet with Fastpitch Mask

Demarini Paradox Fitted Pro Batting Helmet has dual-density padding fitted to your specific size for the perfect fit. Premium rubberized matte finish. Strategic venting system keeps your head cool. Low-profile shell for superior fit. Available sizes: XS, S, M, L, XL, XXL.

**BH9148 - \$49.99**



### Easton Prowess Grip Two-Tone Fastpitch Helmet

Engineered from the ground up for the female athlete. Reinforced flat bill design maximizes sightlines. Integrated facemask with hidden hardware for a streamlined design. BioDri fabric liner absorbs sweat for added comfort. Balanced shell design reinforces impact regions while keeping the helmet lightweight. Helmet and facemask is NOCSAE certified for all levels of play.

**BH9183 - \$59.99**



### Demarini Paradox Protege Batting Helmet with Mask

Demarini Paradox Protege Batting Helmet has dual-density padding covered in antimicrobial fabric sublimated with team colors. Glossy finish. Strategic venting system keeps your head cool. Low-profile shell for a superior fit. Sizes: Youth (Under - 6 7/8"), S (6 3/8" - 7 1/8"), L/XL (7" - 7 5/8").

**BH9153 - \$29.99**



### Easton Prowess Grip w/ Mask Fastpitch Helmet

Engineered from the ground up for the female athlete. Reinforced flat bill design maximizes sightlines. Integrated facemask with hidden hardware for a streamlined design. BioDri fabric liner absorbs sweat for added comfort. Balanced shell design reinforces impact regions while keeping the helmet lightweight. Helmet and facemask is NOCSAE certified for all levels of play.

**BH9184 - \$59.99**



### Demarini Paradox Batting Helmet with Fastpitch Mask

Demarini Paradox Batting Helmet with Fastpitch Mask has dual density padding fitted to your specific size for the perfect fit. Premium rubberized matte finish. Strategic venting system that keeps your head cool. Low profile shell for a superior fit. Sizes: Youth (Under - 6 7/8"), S (6 3/8" - 7 1/8"), L/XL (7" - 7 5/8").

**BH9150 - \$39.99**



### Easton Z5 Solid with Faceguard

Easton Z5 Grip Solid Batting Helmet has a high-impact-resistant ABS shell for maximum protection. Dual-density foam liner for shock absorption and comfort. BioDri padded inner liner absorbs sweat. Wrapped ear pads for durability and comfort. Features a face mask that can be used for baseball or softball. Junior (6 3/8" - 7 1/8"), Senior (6 7/8" - 7 5/8").

**BH9133 - \$39.99**



# HACK ATTACK PITCHING MACHINES

## Hack Attack Pitching Machine - Baseball

The three-wheel design allows the batter to see the ball clearly all the way through the feeding motion, acceleration, and release, just like a live pitcher. The hitter sees when to stride, and the angle of release. This gives an actual live-arm sense of timing and location. Simply turn the dials to effortlessly throw 100 MPH fast balls and breaking balls at any speed. The three-wheel design changes the breaking pitch plane by simply adjusting the wheel speed dials. The elevation adjustment handle will raise or lower the pitch. With a simple turn, you can even move the pitch up or down within the strike zone between pitches.

PM8148 - \$3,299.00



## Junior Hack Attack Pitching Machine - Baseball

The Junior Hack Attack has all of the unique features of the Hack Attack Professional Pitching Machine, including our patented three-wheel design. Delivers all types of pitches including 70+ MPH fastballs and all breaking pitches. Extremely portable, perfect for youth league, backyard, machine pitch games, travel teams, drills at all levels including high school, college and professional. The only pitching machine that will convert quickly to throw a special 7.5" diameter vision training ball.

PM8150 - \$2,199.00



## Hack Attack Team Feeder

Hack Attack Team Feeder holds 75 softballs or 150-baseballs. The feeder will feed a baseball or softball every 5.5-6.5 seconds for continuous hitting. Feeds both the Hack Attack and Hack Attack Junior.

Baseball	PM8159	\$1,799.00
Junior Baseball	PM8159	\$1,799.00
Softball	PM8166	\$1,799.00
Junior Softball	PM8166	\$1,799.00





# HACK ATTACK PITCHING MACHINES

## Hack Attack Pitching Machine - Softball

Hack Attack Softball machine is a three-wheel design so the batter can see the ball clearly all the way through the pitch delivery. The hitter can see when to stride and the angle release, giving an actual live-arm sense of timing and location. With a quick turn of the dials you can effortlessly throw 80+ MPH fastballs, breaking balls, risers, screwballs, and drops. Changes breaking pitch plane by simply adjusting wheel speed dials. The elevation adjustment handle will raise or lower the pitch.

PM8161 - \$3,299.00



## Hack Attack Solo Ball Feeder

Hack Attack Solo Ball Feeder is extremely portable 15 baseball capacity Solo Feeder provides adjustable intervals between pitches. Feeds both the Hack Attack and Junior Hack Attack.

Hack Attack Solo Ball Feeder	PM8160	\$549.99
Hack Attack Softball Solo Ball Feeder	PM8167	\$549.99
Hack Attack Softball Solo Ball Feeder - Junior	PM8167-Junior	\$549.99



## Junior Hack Attack Pitching Machine - Softball

The Junior Hack Attack has all of the unique features of the Hack Attack Professional Pitching Machine, including our patented three-wheel design. Delivers all types of pitches including 60+ MPH fastballs and all breaking pitches. Extremely portable, perfect for youth league, backyard, machine-pitch games, travel teams, drills at all levels including high school, college and professional. The only pitching machine that will convert quickly to throw a special 7.5" diameter vision training ball.

PM8163 - \$2,199.00



# ATEC PITCHING MACHINES



## PITCHING MACHINES

### (A) ATEC M1 Pitching Machine

The M1 is the most complete and capable single-wheel machine. The concave wheel design maximizes pitch speed and accuracy. The M1 is both portable and powerful, designed to be the workhorse on the field and in the cage. Maximum velocity of 70 mph.

Baseball	PM8123	\$1,299.95
Softball	PM8124	\$1,299.95

### (B) ATEC M2 Pitching Machine

The M2 Offensive Training Machine is built to train collegiate-level ball players. When it comes to accuracy, power and portability, no other 2-wheel machine is better equipped than the M2. With the ability to pitch 90mph, the M2 can throw collegiate-level fastballs, curveballs and sliders to any spot in the strike zone. The M2 is used and trusted by many nationally ranked college programs to develop their elite players and take their hitting abilities to the next level.

Baseball	PM8135	\$2,199.95
Softball	PM8136	\$2,199.95

### (C) ATEC M3 Baseball Pitching Machine on Tripod

The ATEC M3 is built to train professional-level ballplayers. The 3-wheel design allows for hitters to have complete visibility of the ball throughout the entire pitch cycle, which improves their timing and increases their pitch recognition. Speed, accuracy, and spin are maximized due to the ball's increased surface contact with the wheels. Equipped to throw 105 mph to train against top pro-level fastballs and breaking pitches. Easy-to-use speed control knobs, pitches can be easily dialed in without making any physical adjustments to the machine.

PM8137 - \$2,899.95

### (D) ATEC R3 Baseball Pitching Machine on Caddy-pod

The ATEC R3 is the top defensive training machine on the market. The R3 throws 10 balls per minute, giving you the ability to execute hundreds of liners, grounders, pop-ups and fly balls in a single practice. The R3 has the lowest recovery time in the industry (approx. .6 sec.). Built to perform every defensive drill, including catcher pop-ups.

PM8138 - \$1,999.95

### (E) ATEC R2 Pitching Machine on Caddy-pod

The ATEC R2 is built for the collegiate-level defensive training. Has the unique ability to rotate and pivot freely while the machine is in use. Allowing you to challenge multiple fielders. Maximize your repetitions for any defensive drill with a 7-second recovery time.

Baseball	PM8139	\$1,999.95
Softball	PM8140	\$2,749.95

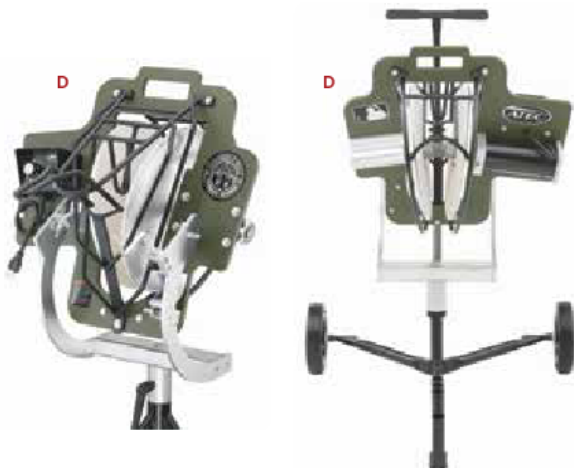
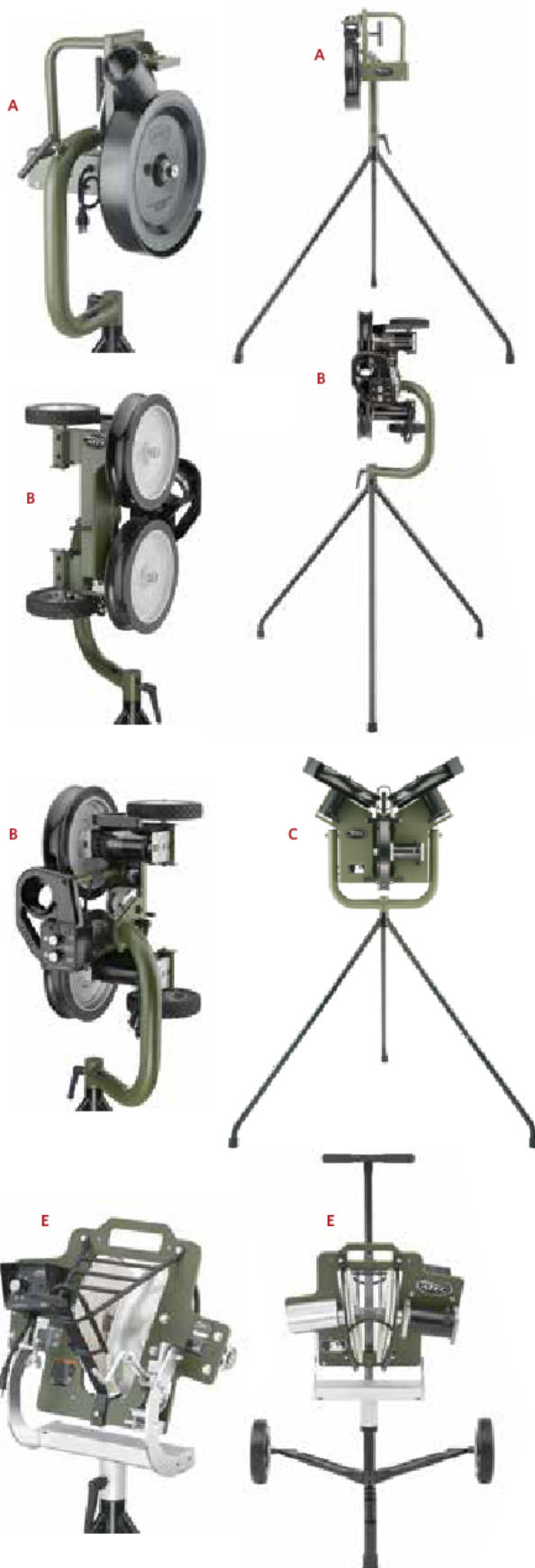



### Iron Mike C-82 Combination Pitching Machines

Throws baseballs and softballs. Max speed 20 - 60 MPH. Lockable arm guard cover. 175 Lbs. This rack-fed pitching machine is the smaller of the Iron Mikes, holding 25 baseballs or 20 softballs at a time. The 2-wheel transport makes this machine easy to transport.

PM8023 - \$1,349.99



### Iron Mike MP4 Pitching Machine

Hopper-fed, arm-style pitching machine throws baseballs and softballs from 25 - 85 MPH. This is an ideal commercial pitching machine as it holds 600 baseballs or 400 softballs\* and is reinforced with extra protection. It can be easily converted between softball and baseball by purchasing the Softball Hand (Slowpitch Ball stop available for SlowPitch softball). Machine weighs 625 lbs.

Pitching Machine	PM8011	\$3,799.99
Cover	PM8026	\$199.99



### Iron Mike MP5 Pitching Machine

Throws pitches from 25-85 MPH. Rack-fed system holding 38 baseballs or 28 softballs. Heavy-duty arm and hand system that is easily converted from baseball to softball with purchase of the Softball Hand. Built-in low voltage remote control with 80-foot cord. 4-wheel transport for quick, easy moving. Lockable arm guard cover.

Pitching Machine	PM8018	\$2,799.99
Cover	PM8024	\$179.99



### Iron Mike MP6 Pitching Machine

Hopper-fed, holds 600 baseballs or 400 softballs. Lockable arm-guard cover. This arm-style pitching machine throws baseballs or softballs\* 25 - 85 MPH. Designed for serious players, prospects and teams. \*The MP6 is set up for baseball by default. It can easily be converted between softball and baseball by purchasing the Softball Hand (Slowpitch Ball Stop available for Slow Pitch Softball).

Pitching Machine	PM8012	\$3,399.99
Cover	PM8026	\$199.99



### Iron Mike Pitching Machine Guard Unit

Extra protection from batted balls. 4'W x 6'H. Heavy #60 gauge net. 1" galvanized pipe framework. Held in place by machine.

Guard Unit	PM8059	\$319.99
Replacement Guard	PM8087	\$34.99



### Pitching Machine Cover For Iron Mike MP5

Protect your Iron Mike pitching machine while not in use. This heavy-duty cover will help prolong the life of your pitching machine. Made of heavy, waterproof nylon. Full-length coverage.

PM8024 - \$165.00

### Pitching Machine Cover For Iron Mike MP4 & MP6

Protect your Iron Mike pitching machine while not in use. This heavy-duty cover will help prolong the life of your pitching machine. Made of heavy, waterproof nylon. Full-length coverage.

PM8026 - \$180.00

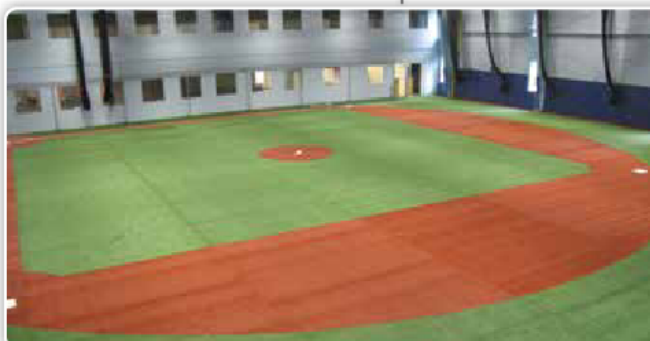

SEE PAGES 4-7  
FOR ALL YOUR INDOOR  
SPORTS FACILITY NEEDS

# JUGS PITCHING MACHINES

## (A) JUGS BP3 Pitching Machine

Throws Changeups: change from fastball to changeup at the touch of a button using the remote control on key chain or manual button located on control panel. Digital Speed Adjustment: 40-90 mph. Select-A-Pitch™ Dial: The BP3 throws the following nine pitches at the turn of a dial. Micro-Adjustment: Pinpoint™ control at your fingertips—the most advanced and easy to use pitch targeting system ever developed for a pitching machine (patent pending). Fastball/Changeup Hitting Circuit: 3 preset hitting circuits allows the machine to automatically change between fastball and changeup giving your hitters a "real" pitcher vs. hitter experience.

### BP3 Pitches:

- Fastballs and Changeups
- Right- and Left-handed Curveballs and Sliders
- Right- and Left-handed Cutters
- Split-finger Fastballs

PM8181 - \$3,395.75

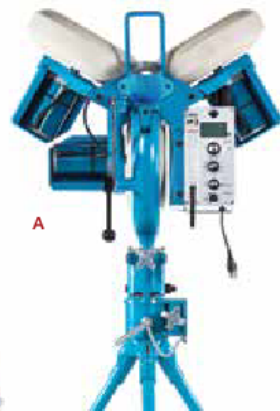

## (B) JUGS Combo Pitching Machine

Quick and easy speed adjustment. Throws from 20-104 MPH. Portable and easy to move and set up. One person can remove the legs and load JUGS into the trunk of a car. Patent "gooseneck" design provides full range of movement to adjust for all types of pitches, including fastballs, drops, and risers. Throws base balls, 11" or 12" softballs, Sting-free balls, JUGS Pearl, JUGS Lite-Flite balls, JUGS Softie balls, JUGS Bulldog and tennis balls. Great for defensive drills. Swivel base casting provides 360-degree movement for fly balls, ground balls, and pop-ups.

PM8019 - \$2,655.99



## (C) JUGS Lite-Flite Combo BB/SB Pitching Machine

Provides a whole range of movement to adjust for all types of pitches—including fastballs, curves and sliders. Simulates speeds up to 85 MPH. Throws base balls and soft balls, Lite-Flite and Bulldog polyballs. Your hitters learn to hit breaking pitches without fear of being hit by the ball. Quick-Change design features exclusive Switch-and-Play Knobs. Go from baseball to softball in a matter of seconds. Swivel-design base casting provides 360-degree movement for fly balls, pop-ups and ground balls.

PM8014 - \$435.99

## (D) JUGS BP®1 Softball Pitching Machine

- New higher speed—Throws up to 70 mph
- Digital readout display
- Throws risers, fastballs and drops
- Safe and simple to operate. Portable and easy to move and set up. Weighs just 75 lbs
- Patented "always see the ball™" delivery system
- Realistic underhand delivery
- Throws 11" or 12" softballs
- 360-degree swivel base—Great for defensive drills
- The BP®1 Softball Pitching Machine comes standard with a 12" ball chute. An 11" ball chute is sold separately.

PM8184 | \$1,350.00 • PM8188 | With Cart | \$1,450.00



## (E) JUGS BP®1 Baseball Pitching Machine

- New higher speed—Throws up to 70 mph
- With its digital readout display, you decide what precise speed is best for your players
- Pitches are thrown from a realistic release point
- Portable and easy to move and set up. Weighs just 75 lbs
- Special non-marking pneumatic tire
- Patented "always see the ball™" delivery system
- 360-degree swivel base—Great for offensive or defensive drills

PM8186 | \$1,350.00

## (F) JUGS BP®1 Combo Pitching Machine for Baseball and Softball

- New higher speed—Throws up to 70 mph
- With its digital readout display, you decide what precise speed is best for your players
- For baseball: The BP®1 comes with a baseball chute and long straight legs
- For softball: The BP®1 comes with a 12" softball chute and curved legs
- Set up for either sport, pitches are thrown from a realistic release point
- Portable and easy to move and set up. Weighs just 75 lbs
- Special non-marking pneumatic tire
- Patented "always see the ball™" delivery system
- 360-degree swivel base—Great for offensive or defensive drills

PM8182 | \$1,400.00



## (G) MVP® Combo Pitching Machine for Baseball and Softball

- New higher speed—Throws up to 60 mph.
- Set your JUGS MVP® to throw at the exact speed you desire:
- With its digital readout display, you decide what precise speed is best for your players.
- For baseball: The MVP® comes with a baseball chute and long straight legs.
- For softball: The MVP® comes with a 12" softball chute and curved legs.
- Set up for either sport, pitches are thrown from a realistic release point.
- Portable and easy to move and set up. Weighs just 56 lbs.
- Special non-marking pneumatic tire.
- Patented "always see the ball™" delivery system.

PM8187 | \$995.00



# FIRST PITCH/RAWLINGS PITCHING MACHINES

## First Pitch Curveball Pitching Machine

Two-wheeled machine that will throw up to 105 MPH. Throws curveballs, sliders, knuckleballs, fastballs, tailing fastballs, and sidearm curves by adjusting the individual wheels to different speeds. Has both a swivel function and a side-to-side adjustment that allows for angling the tires to throw the different pitches. Ball turret makes both left-handed and right-handed pitches possible.

**Combo - PM8118 - \$1,729.00**  
**Baseball Only - PM8116 - \$1,599.00**  
**Softball Only - PM8117 - \$1,599.00**



## First Pitch Baseline Pitching Machine

1/4 HP US-made motor. Steel legs are reversible for baseball or softball. Contoured skid plate for greater accuracy and longer ball life. Simple "no-tools required" switch from baseball to softball in seconds. Full-size pitching machine tire provides long life and minimal wear on balls. Full 360-degree swivel fielding practice. Ground balls to pop flies and everything in between. Made in the USA and comes with a 5-year warranty.

**PM8114 - \$699.00**



## First Pitch Original Pitching Machine

Throws up to 80 MPH. Includes two loading tubes to switch from baseball to softball without tools. Long legs, short legs or both are available for this machine. Throws pitching machine balls or real baseballs and softballs. Angle and speed are adjustable from 20 to 80 MPH for accurate, consistent pitches. Quality construction combines the strength of steel with weight-saving aluminum. Compact and easy to carry to games. Full five-year warranty for residential use or a one-year warranty for commercial use. Adjustment knobs are nickel-plated aluminum; main bracket is black zinc-coated steel; other parts are red powder-coated aluminum.

**PM8109 - \$959.00**



## First Pitch XL Pitching Machine

Throws baseballs and softballs. Baseball and softball chutes included. Will throw any type of ball: stitched, dimple, even foam balls. Fully enclosed motor for ultimate durability. Pivoting legs for baseball or softball height settings. Tips down for ground balls and up for pop flies. Quad surface clamping allows you to lock in the height or set the tension for rapid movement in fielding practice. Ratcheting handles allow for comfortable positioning. Made in the USA and has a five-year warranty.

**PM8115 - \$1,095.00**



## Rawlings 3-Wheeled Pitching Machine

Can throw any pitch from any angle. Exclusive digital control panel for easy pitch setup. Speed range for baseball 40-100 MPH and softball 36-90 MPH. Custom motors with oversized stainless steel shafts for durability. Tough powder-coat finish. Made in the USA.

<b>BASEBALL</b>	<b>PM8121-BB</b>	<b>\$3,199.00</b>
<b>SOFTBALL</b>	<b>PM8121-SB</b>	<b>\$3,199.00</b>
<b>COMBO</b>	<b>PM8121-C</b>	<b>\$3,399.99</b>



## Rawlings 2-Wheeled Pitching Machine

Throws any pitch from any angle. Speed range: 25-105 MPH baseball, 25-88 MPH softball. Super portable - weighs just 59 lbs. LED speed displays. Custom motors with oversized stainless-steel shafts. All stainless-steel fasteners. Tough powder-coat finish. 5-year warranty. Made in the USA.

<b>BASEBALL</b>	<b>PM8122-BB</b>	<b>\$2,099.00</b>
<b>SOFTBALL</b>	<b>PM8122-SB</b>	<b>\$2,099.00</b>
<b>COMBO</b>	<b>PM8122-C</b>	<b>\$2,199.99</b>



## Rawlings Automatic Ball Feeder

Holds 35 baseballs or 29 softballs. Interchangeable turrets for baseball and softball. Wireless remote control included. Open ramp displays ball as it feeds. 2-year warranty. Made in the USA.

<b>BASEBALL</b>	<b>PM8125-BB</b>	<b>\$699.00</b>
<b>SOFTBALL</b>	<b>PM8125-SB</b>	<b>\$699.00</b>
<b>COMBO</b>	<b>PM8125-C</b>	<b>\$899.00</b>



### Rawlings Quatro Pro BBCOR Baseball Bat

Longitudinal Flex re-engineered composite layering for enhanced trampoline across the length of the barrel. Focused Flex reconstructed collar assembly for a stiffer, focused flex eliminating barrel drag while maintaining vibration reduction qualities. Concave light weight end cap creating faster swing speed.

BT1374|-3| \$449.95



### Demarini CF Zen BBCOR Baseball Bat

Constructed with Paraflex™ Plus Composite for the most consistently responsive barrel and handle. 3 Fusion™ Taper is a streamlined design for improved weight distribution and better feel on contact. 3 Fusion™ End Cap optimizes the sweet spot on each barrel by redirecting energy back into the barrel. D-Tak™ premium grip for improved hand control and maximum tackiness. Balanced weight distribution.

BT1390|-3| \$449.95



### Demarini CF Insane BBCOR Baseball Bat

Constructed with Paraflex™ Plus Composite for the most consistently responsive barrel and handle. 3 Fusion™ Taper is a streamlined design for improved weight distribution and better feel on contact. 3 Fusion™ End Cap optimizes the sweet spot on each barrel by redirecting energy back into the barrel. D-Tak™ premium grip for improved hand control and maximum tackiness. End loaded weight distribution.

BT1391|-3| \$449.95



### Louisville Slugger Meta Prime BBCOR Baseball Bat

EKO™ 3 piece composite barrel engineered to the pinnacle of performance; light swinging, monster barrel and the truest sound in the game. 3FX™ connection provides a "stiff" feel on contact while dramatically reducing vibration. RTX™ End Cap design maximizes the barrel shape and improves sound on contact. Balanced swing weight for the ultimate combination of speed and power. LS® Pro Comfort Grip™ for the perfect mix of tack and cushion. 21/32" tapered handle.

BT1416|-3| \$499.95



### Louisville Slugger Prime 919 BBCOR Baseball Bat

3 piece composite with MicroForm™ barrel design for a lighter swing weight and maximum pop. VCX™ technology allows for independent movement between the barrel and the handle that controls vibration and provides unmatched feel on contact. RTX™ End Cap design maximizes the barrel shape and improves sound on contact. Balanced swing weight for the ultimate combination of speed and power. LS® Pro Comfort Grip™ for the perfect mix of tack and cushion. 21/32" tapered handle.

BT1409|-3| \$449.95



### Rawlings Velo BBCOR Baseball Bat

Precision Laser pOp 2.0™ has a lasered groove through sweet spot proven to increase barrel flexibility. Comp-Lite™ Endcap creates balance, generating faster swing speeds. Acoustic Alloy gives the loudest alloy on the market—the proof is in the ping! Velo bat grip designed for comfort and increased bat control.

BT1375|-3| \$299.95





## Easton ADV™ BBCOR Baseball Bat

Barrel layup designed to provide better performance from the first swing and a balanced swing weight. New, stiffer handle layup designed to provide best in class feel. Revolutionary ISO CXN™ 2-piece construction made with NITROCELL™ foam. Isolates the handle from the barrel for a more solid feel while increasing power. "Soft Knob" provides hitters with more leverage and power potential. Reduces vibration and provides more comfort for the bottom hand. SPEED CAP™ provides a more flexible and responsive barrel with a natural sound on impact. Custom LIZARD SKIN™ grip provides the ultimate feel, cushion and tack.

BT1369 | -3 | \$459.95



## Easton Fuse™ BBCOR Baseball Bat

ATAC Alloy construction reinforced with CARBON-CORE™ technology creates the thinnest walls in the game, pushing the limit of performance. Forged Composite Cap for a lighter stiffer composite end cap increases barrel trampoline and provides a speed balanced feel. "Soft Knob" provides hitters with more leverage and power potential. VRSCOR™ handle insert reinforces the handle to create solid feel in the hands. Reduces vibration and provides more comfort for the bottom hand. Custom LIZARD SKIN™ grip provides the ultimate feel, cushion and tack.

BT1370 | -3 | \$349.95



# ★ USA BASEBALL COMPLIANT ★

## ★ Rawlings Quatro Pro™ USA Baseball Bat

Longitudinal Flex re-engineered composite layering for enhanced trampoline across the length of the barrel. Focused Flex reconstructed collar assembly for a stiffer, focused flex eliminating barrel drag while maintaining vibration reduction qualities. Concaved light weight end cap creating faster swing speed.

BT1417 | -8 | \$349.95 • BT1383 | -10 | \$349.95



## ★ Rawlings Velo Hybrid USA Baseball Bat

Precision Laser pOp 2.0™ has a lasered groove through sweet spot proven to increase barrel flexibility. Comp-Lite™ Endcap creates balance, generating faster swing speeds. Acoustic Alloy gives the loudest alloy on the market—the proof is in the ping! Velo bat grip designed for comfort and increased bat control.

BT1384 | -10 | \$199.95 • BT1385 | -5 | \$199.95



## ★ DeMarini CF Zen Balanced USA Baseball Bat

Paraflex™ Plus Composite creates the most consistently responsive barrel and handle possible. 3 Fusion™ Taper is a streamlined design for improved weight distribution and better feel on contact. 3 Fusion™ End Cap optimizes the sweet spot on each barrel by redirecting energy back into the barrel. Features CAMO-D grip for premium performance.

BT1418 | -10 | \$349.95



## ★ Easton Beast Speed Hybrid USA Baseball Bat

Advanced Thermal Alloy construction provides the lightest and strongest aluminum barrel in a speed balanced swing weight to emphasize bat speed at contact. Speed Cap™ provides a more flexible and responsive barrel while also enhancing the sound of the bat. Dynamic Feel System™ with Connexion+™ technology provides a rock-solid feel. 2-piece hybrid design combines EXACT™ Carbon and ATAC Alloy for outstanding all-around feel and performance. Custom Lizard Skin™ grip provides the ultimate feel, cushion and tack.

BT1438 | -10 | \$259.95



## ★ Louisville Slugger Prime® 919 USA Baseball Bat

3-piece composite MicroFoam™ barrel maximizes barrel size while maintaining peak performance and pop on contact. Patented VCX™ technology allows for independent movement between the barrel and the handle that controls vibration and provides unmatched feel on contact. RTX™ end cap design maximizes the barrel shape and improves sound on contact. Balanced swing weight for the ultimate combination of speed and power. LS Pro Comfort Grip™ provides the perfect mix of tack and cushion. Handle tapered 7/8"

BT1411|-10| \$349.95



## ★ Louisville Slugger Select 719 USA Baseball Bat

3 Piece Hybrid Construction with ST 7U1+ alloy barrel and composite handle for maximum durability and power on contact. Patented VCX™ Technology allows for independent movement between the barrel and the handle that controls vibration and provides unmatched feel on contact. Speed Ballistic Composite End Cap for increased swing speed and maximum control. Balanced swing weight for the ultimate combination of speed and power. LS Pro Comfort Grip™ for the perfect mix of tack and comfort. 7/8" tapered handle.

BT1420|-10| \$299.95 • BT1421|-8| \$299.95 • BT1422|-5| \$299.95



## ★ Easton Ghost® X Evolution USA Baseball Bat

EXACT™ Carbon - Engineering x Advanced Carbon Technology handle/barrel construction provides better feeling in the hands and optimized barrel performance. CXN EVOLUTION™ construction uses NITROCELL™ foam to create a lighter, higher performing connection between handle and barrel. SPEEDCAP™ provides a more flexible and responsive barrel while also enhancing the sound of the bat. Enhanced DYNAMIC FEEL SYSTEM™ integrates EXACT™ Carbon construction and CXN EVOLUTION™ technology to provide the best feeling 2-piece bat in the game. 2-piece speed balanced design provides a lightweight swing weight for more speed behind the ball at contact. Custom LIZARD SKIN™ grip provides the ultimate feel, cushion and tack.

BT1371|-10| \$349.95



## ★ Easton Ghost® X Evolution USA Baseball Bat

EXACT™ Carbon - Engineering x Advanced Carbon Technology handle/barrel construction provides better feeling in the hands and optimized barrel performance. CXN EVOLUTION™ construction uses NITROCELL™ foam to create a lighter, higher performing connection between handle and barrel. SPEEDCAP™ provides a more flexible and responsive barrel while also enhancing the sound of the bat. Enhanced DYNAMIC FEEL SYSTEM™ integrates EXACT™ Carbon construction and CXN EVOLUTION™ technology to provide the best feeling 2-piece bat in the game. 2-piece speed balanced design provides a lightweight swing weight for more speed behind the ball at contact. Custom LIZARD SKIN™ grip provides the ultimate feel, cushion and tack.

BT1423|-8| \$349.95 • BT1424|-5| \$349.95



## ★ DeMarini Voodoo Balanced USA Baseball Bat

Half and Half featuring ultra-premium x14 alloy barrel for improved durability and maximum pop. Paraflex™ Plus Composite handle design for a more responsive premium feel on contact. 3 Fusion™ Taper streamlined design for improved weight distribution and better feel on contact. 3 Fusion™ End Cap optimizes the sweet spot on each barrel by redirecting energy back into the barrel.

BT1401|-10| \$249.95 • BT1419|-5| \$249.95



## ★ Rawlings 5150 USA Baseball Bat

Engineered with pOp 2.0™ creating a larger sweetspot and improving feel. 5150® Alloy is Rawlings' most radically responsive aerospace-grade alloy built for performance and durability. Hyper-lite Speed Cap for a lighter feel and faster swing speed.

BT1439|-11| \$133.99 • BT1440|-10| \$133.99 • BT1441|-5| \$133.99





## Easton Ghost Fastpitch Bat

Double Barrel technology is the ultimate combination of feel, pop and sound. **XTX™** Xtra Tough Resin Matrix technology provides durability and flexibility for the compression barrel in the game. 2-piece **ConneXion+™** technology features **NITROCELL™** foam to create lighter and better feeling connection between handle and barrel. Ultra-thin 29/32" handle with all new 1.2mm **HYPERSKIN™** grip. Available in ASA or USSSA models.

BT1425|-11| \$349.95 • BT1426|-10| \$349.95 • BT1427|-9| \$349.95



## Rawlings Quatro Pro Fastpitch Bat

Longitudinal Flex re-engineered composite layering for enhanced trampoline across the length of the barrel. Suspended Inner Barrel gives a simplified inner barrel balance swing weight promoting high velocity swing speeds. Focused Flex reconstructed collar assembly for a stiffer, focused flex eliminating barrel drag while maintaining vibration reduction qualities.

BT1428|-9| \$349.95 • BT1429|-10| \$349.95



## Louisville Slugger PXT™ X19 Fastpitch Bat

Mass **FX™** loaded sweet spot technology places a greater amount of mass directly behind the sweet spot, creating more momentum and effortless power. **VCX™** technology allows for independent movement between the barrel and the handle that controls vibration. **PWR STAX™** barrel technology evenly distributes the load on impact across the entire barrel for ultimate results. Power balanced swing weight that is perfect for elite hitters.

BT1430|-10| \$399.95 • BT1431|-9| \$399.95 • BT1432|-8| \$399.95



## Louisville Slugger LXT X19 Fastpitch Bat

**PBF™** Barrel Technology provides maximum pop. **VCX™** technology allows for independent movement between the barrel and the handle that controls vibration and provides unmatched feel on contact. **LS Pro Comfort Grip™** for the perfect mix of tack and cushion. Balanced swing weight for extreme control and maximum swing speed. Ultra-light weight **X-Cap™** design provides improved swing speed and the low profile design increases the barrel length for a larger sweet spot.

BT1433|-8| \$349.95 • BT1434|-9| \$349.95 • BT1435|-10| \$349.95 • BT1436|-11| \$349.95 • BT1437|-12| \$349.95



## DeMarini CF Zen

**Paraflex™** Plus composite design that creates the most consistently responsive barrel and handle possible. 3 Fusion Taper designed for improved weight distribution and better feel on contact. 3 Fusion™ End Cap optimizes sweet spot, sound and feel throughout the barrel.

BT1408|-11| \$349.95



## DeMarini CF Insane

**Paraflex™** Plus composite design that creates the most consistently responsive barrel and handle possible. 3 Fusion Taper designed for improved weight distribution and better feel on contact. 3 Fusion™ End Cap optimizes sweet spot, sound and feel throughout the barrel.

BT1406|-10| \$349.95



**SEE OUR FULL LINE OF BATS AT ONDECKSPORTS.COM**

# CUSTOMIZED BAT AND HELMET RACKS FOR YOUR TEAM!



**OVERHEAD STORAGE**



**HELMET  
RACKS**



**SLIM  
FURNISHINGS**





**BAT RACKS**



**CONTACT US FOR YOUR FREE QUOTE TODAY**



**HELMET-BAT RACK COMBOS**



## Original Jack Corbett MLB Hollywood Bases (Set of 3)

Recommended for Major League, minor league, semi-pro, college, and high school baseball. This base has an extended tapered lip that virtually eliminates all the edge turn-up that cheap imitation bases have. The highest quality, longest-lasting base available. Currently used by all 30 Major League Baseball teams. The longest-lasting pro-style bases available in the game today. Made from high-quality rubber. Stands up well in all weather conditions. Does not include anchors and plugs.

Set includes all 3 bases.

**BA2013 - \$199.99**

**BA2079 - Package (includes: bases, anchors and plugs) - \$239.99**

## ANCHORED BASES

### Pro Anchored Bases (Set of 3)

Pro anchored base, heavy-gauge rubber cover over high-density foam interior with a rust-proof bolted stanchion pan. Set includes: 3 bases and 3 hinged ground anchors. 15" x 15" x 3".

**BA2022 - \$179.99**



### Low-Profile Pro Model Bases (Set of 3)

Offers a lower, more sleek look for your field. The low-profile bases are constructed with durable, molded rubber. Bases come complete with anchors and plugs. Includes 3 bases. Breakaway-style molded rubber bases.

Size: 15" x 15" x 2.5".

**BA2021 - \$139.99**



### Pro-Style Bases Set (Two Pro-Style Rubber Bases and a Double 1st Base)

This Pro-style Bases Set includes one double first base, plus two standard pro-style rubber bases. White side for the fielder, orange side for the runner. These bases are manufactured with a heavy-duty vinyl covering and a soft re-bonded foam filler. For all levels of play.

**BA2046 - \$399.99**







## HOME PLATES

### In-Ground Home Plate

Home plate is a regulation size 3" thick home plate with no corners or edges to catch players' spikes. Comes ready to install. Beveled edges and sides with a one-piece vinyl cover. Entire exterior molded vinyl 5/16" thick. White top surface. Manufactured with a wood-filled core.

**BA2047 - \$99.99**



### Waffle Bottom Home Plate

Cost-efficient home plate that can be used indoors and outdoors. Regulation size. Easy to move around and store. No installation needed. Great home plate for baseball and softball play at home or on the field.

**BA2001 - \$14.99**



### Schutt Pro Home Plate

Schutt Pro Home Plate is manufactured with high-durability molded rubber construction. This removable home plate comes with a stanchion-mounted steel plate and ground anchor to allow for a stable, yet removable installation method. Easy to install. Easy to remove after the game or practice.

**BA2025 - \$103.99**



## SAFETY BASES

### Schutt Kwik Release Bases (Set of 3)

Approved by Little League. Patented design compresses upon impact. Easily installs in standard 1 3/4" square ground anchors. Rubber base won't absorb water and repels dirt. 15" x 15" x 3". Set of three bases. Base plugs and ground anchors sold separately.

**BA2028 - \$359.99**



### Rogers Break-Away Youth Base System

Recommended for males up to 12 years old and females up to 16 years old. Used in Little League World Series. Progressive compression-and-release bases to absorb improper slides and, in extreme cases, disengage all together. Includes 3 base tops, 3 base plates, 3 anchor housings, 3 rubber anchor plugs and a dig-out tool.

**BA2035 - \$479.99**



### Soft Touch 15" Bases (Set of 3)

These Soft Touch Progressive release bases are designed to flex and absorb energy as a player slides into the base. In the case of a short slide, the "progressive release" action allows the base to flex until enough force is applied to "pop" the base free from its mount. Includes set of three, 15" bases and in-ground mounts.

**BA2014 - \$429.99**

**BA2050 - Bases Only - \$359.99**



**RUBBERS****(A) Pro 4-Way Pitching Rubber**

Pitching rubber used in Major League Baseball. Quality manufactured with 4 sides so that it can be rotated for extended life. A great investment for your field. Molded rubber is designed to withstand the rigors of everyday pitching.

**BA2006 - \$89.99**

**(B) Youth 4-Way Pitching Rubber**

Quality manufactured with 4 sides so that it can be rotated for extended life. A great investment for your field. Molded rubber is designed to withstand the rigors of everyday pitching.

**BA2009 - \$44.99**

**(C) Pro Step-Down Pitching Rubber**

Give your pitchers better footing and stability with our Pro Step-Down Pitching Rubber manufactured with a wooden core and a solid molded rubber cover. The pitching rubber's front extension prevents holes in front of rubber and provides even, firm footing. Made with a heavy-duty white rubber cover. This pro-model, adult-size pitching rubber is a great alternative to traditional flat style.

**BA2048 - \$83.99**

**(D) Schutt Pro 4-Way Pitching Rubber**

Molded rubber and includes an interior tube to maximize longevity. An interior aluminum tube for added professional strength.

**BA2029 - \$119.99**

**(E) Youth Step-Down Pitching Rubber**

Perfect for youth games or practice. Step-Down offers better footing for young players. Manufactured using a heavy-duty, all-rubber construction.

**BA2016 - \$54.99**

**THROW-DOWN BASES****(F) Throw-Down Waffle Bases (Set of 3)**

Ease of use is the feature of these waffle-style, throw-down bases. The suction bottom design stabilizes the base and helps minimize the risk for injury. Set of 3 waffle-bottom bases. The rubber and beveled construction provides traction to prevent slippage. Great for indoor or outdoor play. Rubber bases with beveled edge construction. Bases have ½" thickness. Great base for practices.

**BA2002 - \$27.99**

**(G) Youth Target Bases**

Set of 3 bases. Highlighted orange corner to reduce injury, while also teaching proper base-running techniques. Size: 14" x 14" x 2".

**BA2015 - \$49.99**

**(H) Soft Touch Turf Bases (Set of 3)**

Soft Touch Turf is designed for use on synthetic playing fields with a turf depth of 1". Our unique design requires no mounting system and sits securely on the synthetic turf. Easy to install, Soft Touch Turf can remain in-ground year round or set up for game-time. Set of 3 bases.

**BA2077 - \$619.99**

A,B



C



D



E



F



G



H





## Rawlings Velo Catcher's Set

- TRI-TECH™ padding keeps air circulating between chest protector and body allowing cool air in and releasing the hot air
- Set Includes: Rawlings Velo Helmet, Rawlings Velo Chest Protector, Rawlings Velo Triple-knee leg guards
- AB Wedges remain flat for added ball rebound control
- Dynamic Fit System™ & flexible design allow for a comfortable and optimal fit for the Chest Protector

CG1115-Adult - \$299.99  
CG1115-Int - \$269.99  
CG1115-Youth - \$259.99

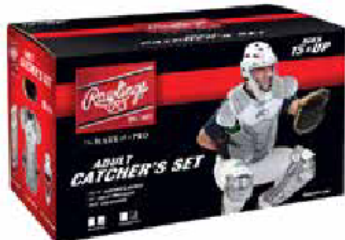

## Rawlings Renegade Catcher's Set

- Includes: COOLFLO® hockey-style catcher's helmet, Rawlings Renegade Chest Protector, Rawlings Renegade Triple-knee leg guards & a free equipment bag
- Comes in color Black Only
- Adult Ages 12-15

CG1114-Adult - \$169.99  
CG1114-Int - \$159.99



## Easton Elite X Catcher's Set

Includes: Elite X Catcher's Helmet, Chest Protector, and Shin Guards

### Elite X Catcher's Helmet

- Available in: Large 7 1/8 - 7 1/2 - Small 6 1/2 - 7 1/8
- Black steel cage designed with a flat middle bar for increased visibility
- ABS plastic shell with strategic airflow vents
- Plush wrapped padding with breathable air mesh and BioDri™ moisture wicking fabric on forehead
- Removable and washable forehead and chin pads.
- Meets NOCSAE standard for all levels of play

### Elite X Chest Protector

Available in: Adult 17", Intermediate: 16" and Youth 15"

- Stacked memory foam in ab area provides improved rebound control
- Adjustable shoulder cap
- 4-point webbing strap system with neoprene back organizer for a tight fit
- Heavy-duty black coated steel inset waist clip for a better wrapped fit
- Meets NOCSAE Commotio Cordis standard

### Elite X Leg Guards

- Available in Adult: 16.5", Intermediate 15.5", and Youth 14"
- Reinforced knee and thigh connection improves fit and security when moving in and out of the squat
- Wide-set knee design provides a larger surface area in the blocking position and explosive side to side movements
- Removable inner knee and shin pads for adjusted fit and comfort
- Vented shell design for increased air flow and breathability
- Triple knee design for Adult and Intermediate sizes (YOUTH double knee design)
- Toe extension on Adult model only

CG1192 - Youth (Age 9-12) - \$329.99  
CG1191 - Intermediate (Age 13-15) - \$339.99  
CG1190 - Adult (Age 15 & Up) - \$349.99



## Wilson C1K Catcher's Set

Kit Includes Catcher's Helmet, Chest Protector, and Leg Guards

### C1K Helmet

- Glossy finish
- Removable moisture wicking chin pad
- Adjustable straps for custom fit
- Meets NOCSAE protection Standards

### C1K Chest Protector

- High density foam padding for ultimate comfort and protection
- Removable shoulder caps for increased mobility
- Over the shoulder adjustable harness
- Precision, angled pad design to help block the ball straight down

### C1K Leg Guards

- Inner knee pad protects knees, removable for washing
- Overlapping thigh pieces for maximum protection
- Lightweight premium grade ABS plastic
- Adjustable metal buckles for easy on/off and snug fit

CG1183-Adult - \$299.99

CG1183-Int - \$249.99



## Easton M5 Qwikfit Catcher's Set

### M5™ Qwikfit™ Catcher's Helmet

- Easy to adjust QwikFit™ 3-point strap system
- Engineered kid-fit optimizes protection, visibility and comfort
- Dual-density foam liner for shock absorption and comfort
- Meets NOCSAE standard for all levels of play
- Colors: Black, Red, Navy, Royal

### M5™ Qwikfit™ Chest Protector

- Easy to adjust QwikFit™ 2-point strap system
- Multi-layer perforation allows heat to dissipate
- Dual-density foam with extra protection in the chest and collarbone region
- Colors: Black/Black, Red/Black, Navy/Black, Royal/Black

### M5™ Qwikfit™ Leg Guard

- Three-piece shin provides adaptability for kids of all sizes
- Easy-to-grab buckles and QwikFit™ quick adjustment.
- Perforation allows heat to dissipate
- TRUBLOCK™ anti-roll design creates stability in and out of the blocking position

CG1110-Youth (Age 9-12) - \$145.99

CG1110-Junior (Age 6-8) - \$145.99



# CATCHER'S SETS / EQUIPMENT BAGS

## Fastpitch Contour Fit Chest Protector

- 17mm polyurethane foam rib pads • Polyester satin front cover in a full range of team colors
- Abrasion resistant braided nylon binding • Cowhide leather strap anchors
- Rust resistant, nickel plated steel hardware • 100% Nylon sewn

CG1142-Adult - \$34.99 • CG1143-Int - \$29.99  
CG1144-Youth - \$29.99

## Fastpitch Contour Fit Leg Guards

- 2 knee caps • Shin length 16.5" • Ankle wings, full padding • 4 straps

CG1145-Adult - \$49.99 • CG1146-Int - \$44.99  
CG1147-Youth - \$39.99



## Helmax Catcher's Set

- CM3 HEL-MAX® one-piece youth headgear
- Contour fit premium lightweight chest protector
- Contour fit Air-Tech® leg guards

CG1132 (Age 9-12) - \$115.99  
CG1133 (Age 6-9) - \$87.99



## Triple Play Catcher's Set

- Hockey style headgear • Contour fit premium lightweight chest protector
- Contour fit Air-Tech® leg guards

CG1130 (Age 9-12) - \$131.99  
CG1131 (Age 6-9) - \$121.99



## EQUIPMENT BAGS

### Easton E900G Equipment Bag

Designed using rugged and extremely durable materials and a telescoping handle for transportation to the field. Wide set wheels with an axle and full bottom rails provide strength and durability. A large top pocket holds 15-20 bats. The top panel has three pockets, one felt lined, and two for team or personal items. Vented pockets minimize odor and allow equipment to dry faster. Dimensions: 39" L x 16" W x 17.25" H.

EQ1010 - \$199.99



### Diamond Delta Gear Bag

Diamond Delta Gear Bag is designed with rugged 600-denier fabric and a u-shape zippered main compartment. This bag features two padded zippered bat sleeves, each holds one full size bat and easy access zippered side pocket. Telescopic pull handle and dual carry handles with clasp. Dimensions: 35" L x 16" W x 15" H.

EQ1006 - \$86.99



### Schutt Team Equipment Bag

Schutt Large Team Equipment Bag is an oversized, single compartment bag that holds all of your gear. Heavy-duty polyester with polyurethane backing and 2" nylon webbing shoulder and handle straps. Dimensions: 35" L x 16" W x 16" H.

EQ1025 - \$35.99



### Deluxe Equipment Bag

Deluxe Equipment Bag utilizes a "U" shaped zipper top for easy access and large side pocket. Constructed with tough 600D polyester fabric and a heavy-duty wheel system. Two screen printable areas and two end handles for easy lifting. Dimensions: 36" L x 16" W x 18" H.

EQ1030 - \$50.99



### Diamond Equipment Bag

Diamond Equipment Bag is constructed with heavy-duty water-resistant fabric. Utilizing a u-shaped zippered main compartment and shoulder straps that can be worn backpack style this is an excellent equipment bag. Diamond mesh inset for ventilation. Dimensions: 36" L x 15" H x 12" W.

EQ1009 - \$39.99



### Rawlings Ball Bag

The Rawlings Ball Bag holds five dozen baseballs. Has two accessory side pockets. Durable velcro close hand straps. Heavy-duty molded bottom.

EQ1001 - \$29.99







## COMPLIANT WITH NCAA® 2018 RULE CHANGE 2.12

### Varsity Baseball Foul Poles 12' (Pair of 2)

- Powder-coated optic yellow, making it easy to see day or night.
- Constructed of heavy-duty 3-1/2" OD heavy-wall steel pipe with an 18" wide visual steel fencing wing on the top of the poles.
- Sold in pairs.
- Three-year guarantee.

FE7048 - \$999.99

### Varsity Baseball Foul Poles 15' (Pair of 2)

- Powder-coated optic yellow, making it easy to see day or night.
- Constructed of heavy-duty 3-1/2" OD heavy-wall steel pipe with an 18" wide visual steel fencing wing on the top of the poles.
- Sold in pairs.
- Three-year guarantee.

FE7049 - \$1,259.99

### Varsity Baseball Foul Poles 20' (Pair of 2)

- Powder-coated optic yellow, making it easy to see day or night.
- Constructed of heavy-duty 3-1/2" OD heavy-wall steel pipe with an 18" wide visual steel fencing wing on the top of the poles.
- Sold in pairs.
- Three-year guarantee.

FE7050 - \$1,471.99

### Varsity Fastpitch Foul Poles 20' - Orange (Pair of 2)

- One piece welded steel construction designed for permanent or semi permanent installation.
- Main upright is 3-1/2" O.D. SS 40 zinc coated steel tubing.
- 18"W x 12'H fully welded wing panel includes heavy duty 1-1/2" x 13 gauge expanded metal mesh, designed to optimize air passage.
- Optional ground sleeves for semi-permanent installation available separately.

FE7224 - \$1,499.99

### 20' Foul Poles

These foul poles are 20' tall and feature a 4" diameter aluminum pipe. They come with standard wings start 8' above finished grade and consist of 1/8" stamped aluminum sheet with double reinforced bends making them much more durable and longer lasting. Powder coated with yellow (baseball), optic orange or white (softball) colors. Foul poles sold as a pair.

FE7221 - \$2,240.00

### Varsity Fastpitch Foul Poles 30' - Orange (Pair of 2)

- One piece welded steel construction designed for permanent or semi permanent installation.
- Main upright is 3-1/2" O.D. SS 40 zinc coated steel tubing.
- 18"W x 12'H fully welded wing panel includes heavy duty 1-1/2" x 13 gauge expanded metal mesh, designed to optimize air passage.
- Optional ground sleeves for semi-permanent installation available separately.

FE7225 - \$2,599.99



Available  
In White

### All-Steel Drag Mat

Rust-resistant galvanized finish. Reversible; use either side. Rugged construction. A 1/4" polypropylene pull rope with a wooden handle is attached to the mat by chain hooks. Mesh size: 1" x 1".

3'W x 5'L	FE7002	\$143.00
6'W x 6'L	FE7003	\$289.00
6'W x 1.5'L	FE7004	\$119.99

### (A) Cocoa Drag Mat

Constructed from natural cocoa fibers that "float" across the surface, producing a finish with minimal buildup of your infield mix. Tow chain and clips included. 1-year guarantee. Solid-steel twin blade cutting edge to level rough spots. Great on turf to break up core aeration plugs and smooth in top-dressing materials. Features a handle grip for easy transport.

4' x 2'	FE7063	\$140.99
6' x 2'	FE7064	\$190.99
6' x 4'	FE7065	\$280.99

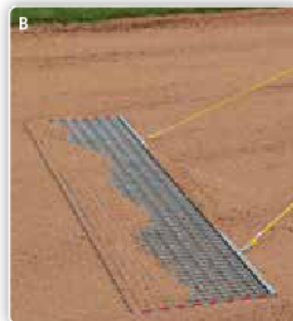
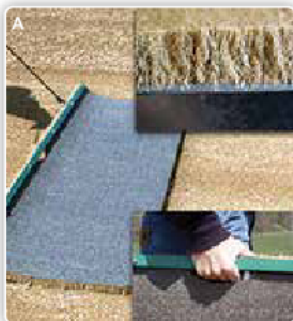

### (B) Rigid Steel Drag Mats

Drag attachments are on 4' and 6' sides. The rigid drags help to cut down high spots and fill low spots. Great for use between innings or for day-to-day maintenance. Can be pulled by hand, tractor or other grooming machine.

4'W x 1.5'L	FE7187	\$115.99
4'W x 2'L	FE7188	\$139.99
4'W x 3'L	FE7189	\$149.99
6'W x 1.5'L	FE7190	\$169.99
6'W x 2'L	FE7191	\$199.99
6'W x 3'L	FE7192	\$209.99



### (C) Flex Steel Mop

Designed for small areas that are difficult to groom. Great for pitching mounds, batter's boxes, basepaths, on-deck circles, and other small cutouts. Top-quality steel construction.

FE7084 - \$139.99

### (D) Cocoa Finishing Mop

Use in small areas of the infield. Great for pitching mounds, batter's boxes, basepaths, on-deck circles, and any other cutouts. Constructed from strong aluminum.

FE7085 - \$99.99



### (E) Infield Dirt Tamp

Color may vary. Pack dirt around home plate with our heavy-duty tamp.  
**FE7010 - \$79.99**



### (F) Field Rake

Handle has a non-slip vinyl grip, as well as a high-grade aluminum head and bracing. Made of an aluminum/magnesium alloy.  
**FE7015 - \$74.99**

### (G) 36" Non-Absorbent Squeegee

Ideal for pushing water off tennis courts, golf greens, sports fields, etc. Aluminum frame. Best for turf or clay applications, but can also be used on hard surfaces.  
**FE7041 - \$119.99**

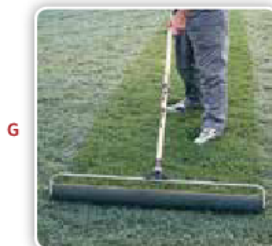

### (H) Double Play Scarifier Broom

Scarifying edge makes this perfect for breaking up packed soils. Bristles are removable for easy replacement or for adjusting the broom's stiffness. Great for field lips. 2 rows of bristles. Aluminum handle.  
**FE7042 - \$99.99**

### (I) Diamond Pump

Pumps 20 gallons per minute. Base disk prevents mud and debris from being drawn into the pump. Tough ABS construction.  
**FE7046 - \$99.00**

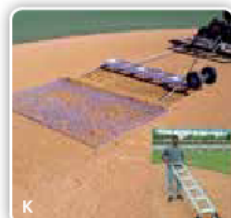

### (J) Big League Field Drag

Will condition a 6'-wide path in one pass. Designed to break up dirt or cinders on the baseball field or track. Designed to hold cement blocks for additional weight. With steel cutting teeth down, it tears up the dirt. With angle iron down, it levels the playing surface. Features 46, 4.5" teeth. The teeth are staggered with 3" gaps. Heavy-duty chain trails the unit to break up dirt clumps. Recommended to be pulled by a tractor. 1-year guarantee.  
**FE7059 - \$362.99 • Replacement teeth, 46-piece set FE7194 - \$154.99**

### (K) Diamond Digger Combo Field Groomer

Features 4.5" sharpened and hardened steel cutting teeth which are replaceable once worn, for cost saving. Pneumatic wheels roll for effortless transport. Measures 14"W x 6'L with a galvanized steel frame. Pull chain provided on front and hooks on rear for attachment of drag mat. Designed to hold a maximum of 3 cement building blocks-not included- for additional weight when necessary. Remove wheels to turn groomer over and utilize as a leveling sled. Recommended to be pulled behind a tractor. Heavy-duty drag mat included.  
**FE7066 - \$625.99**

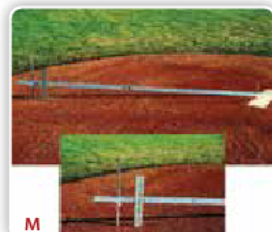
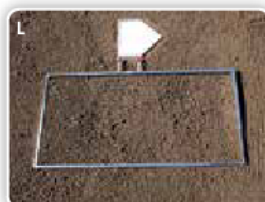

### (L) Adjustable Batter's Box Template

Easy to create different sizes by simply sliding the template. Mark your batter's box with our template for easy field mark creation for your team. 1" galvanized steel construction.  
**FE7001 - \$209.99**

### (M) Mound Slope Gauge

An accurate way to measure the proper height and taper of any mound. Includes bubble level, metal ruler, 2 support rods, and mound construction directions. One person can use the mound slope gauge effectively.  
**FE7079 - \$189.99**



### (N) Sifting Scoop

For cleaning rocks, glass, and unwanted debris from dirt and sand. Lightweight, heavy-duty, one-piece molded construction.  
**FE7088 - \$139.99**

### (O) Double Play Monster Drag Brooms

Includes a scarifier edge allowing it to perform double duty. Functions as a broom and a rake by simply flipping it over. The bristle side helps you to have the perfect finishing drag.  
**FE7111 - \$235.99**

FOR A FULL LINE OF FIELD EQUIPMENT  
 SEE OUR WEBSITE AT  
[ondecksports.com/Products/Field-Maintenance](http://ondecksports.com/Products/Field-Maintenance)



### Professional Streamliner Chalker

Heavy-duty steel frame and rugged molded plastic hopper withstands daily wear and tear. One-button retractable handle for easy on-site storage in storage boxes. Quick change between 2" & 4" lines. Semi-transparent hopper cover and variable flow control to better monitor chalk usage. Flexible brush agitator helps improve chalk flow for more consistent lines.

3-Wheel Chalker 50 lb.	FE7090	\$439.99
4-Wheel Chalker 70 lb.	FE7091	\$489.99

### (A) Field-Striping Paint

12 cans per case. Available in Black, Gold, Gray, Green, Light Blue, Maroon, Navy, Orange, Purple, Red, Royal Blue, Vegas Gold, White, and Yellow. Water-resistant and extremely durable. Visible on grass for weeks. Will not flake or wash away.

Field-Striping Paint - White - \$49.99 • Colored - \$49.99-\$59.99



### (B) Collegiate Dry Line Marker

All-steel unit with galvanized steel bucket. Adjustable from 2" to 4" lines. Guide stripe on lid for easier application. 4 heavy-duty wheels. Steel axle. ABS plastic agitator.

60 lb.	FE7007	\$173.99
35 lb.	FE7036	\$143.99
100 lb.	FE7037	\$214.99

### (C) Professional Dry Line Marker

18-month warranty. 18-gauge steel hoppers and frame. Handle-mounted control levers for instant on/off. Precision control for 2" or 4" lines. Oversized foam-rubber handgrips. On 100 lb. and 50 lb. models, four pneumatic wheels handle easily over any terrain. 25 lb. and 10 lb. models have two wheels. Tough, powder-coated forest green finish.

10 lb.	FE7183	\$89.99
25 lb.	FE7184	\$169.99
50 lb.	FE7185	\$349.99
100 lb.	FE7186	\$369.99







## WANT A DEDICATED STRENGTH AND CONDITIONING AREA? WE CAN HELP!

### Rollout Rubber Flooring

Minimum purchase 60 square feet (4' x 15'). Rolled rubber eliminates seams and enhances the appearance and longevity of your sports facility or home gym. Environmentally friendly, made from recycled rubber content and cost-effective. Available in custom colors.

8 mm	Black	RB0016	\$175/sq. ft.
8 mm	Blue	RB0002	\$1.89/sq. ft.
8 mm	Gray	RB0017	\$1.89/sq. ft.
8 mm	Blue/Gray	RB0018	\$1.89/sq. ft.
8 mm	Red	RB0019	\$1.89/sq. ft.
8 mm	Yellow	RB0020	\$1.89/sq. ft.
8 mm	Red/Gray	RB0024	\$1.89/sq. ft.
8 mm	Purple	RB0025	\$1.89/sq. ft.
8 mm	Green	RB0027	\$1.89/sq. ft.

### Quickship Rollout Rubber Flooring

Available in 8mm thick. Each roll is 4' wide and comes in either 25' or 50' long. Ideal for high-performance areas. Can withstand rolling loads. Easy installation. Durable and fade resistant. Easy-to-clean with: vacuum or broom and damp mop. Sound and shock absorbent. Slip-resistant wet or dry.

25'	Black	RB0030	\$175.00/roll
25'	Blue	RB0031	\$189.00/roll
25'	Gray	RB0033	\$189.00/roll
25'	Red	RB0034	\$189.00/roll
50'	Black	RB0036	\$350.00/roll
50'	Blue	RB0037	\$378.00/roll
50'	Gray	RB0039	\$378.00/roll
50'	Red	RB0040	\$378.00/roll

\*Colors are 10% fleck

### Interlocking Rubber Tiles

Minimum purchase of 50 tiles. Interlocking. Custom colors and logos available. Sound- and shock-absorbent. Easy installation and maintenance. Slip-resistant, wet or dry. Extremely durable. Low lifecycle costs.

8 mm	Blue	23"x23"	RB0001	\$11.09/tile
8 mm	Black	23"x23"	RB0004	\$9.61/tile
8 mm	Gray	23"x23"	RB0005	\$11.09/tile
8 mm	Blue/Gray	23"x23"	RB0006	\$11.09/tile
8 mm	Red	23"x23"	RB0007	\$11.09/tile
8 mm	Yellow	23"x23"	RB0008	\$11.99/tile
8 mm	Red/Gray	23"x23"	RB0012	\$11.99/tile
8 mm	Purple	23"x23"	RB0013	\$11.99/tile
8 mm	Green	23"x23"	RB0015	\$11.99/tile



# TAKE YOUR TO THE NEXT

A

**Agility Turf with Inlaid Agility Ladder**

This is a premium padded artificial turf that is used in some of the top gyms and training centers in the country. 15' Inlaid agility ladder allows for more precise training. High quality realistic yarns and fibers make it look and feel like real grass. Turf has a soft feel for athletes but holds up to high traffic areas and high impact workouts. Includes 5mm foam padding and does not require infill. Available with hashmarks and without hashmarks.

12' x 50'	Hashmarks+Ladder	\$4,900.00
12' x 50'	Ladder	\$3,900.00

**Sled Strips**

Artificial turf sled strips are extremely durable and are perfect for functional fitness - including sled pushes and pulls, tire flips and more. Whether you are pushing or pulling a sled across your facility the sled strips can reduce friction and improve the life of your floors. Product comes in green turf.

3' x 30'	AT6031	\$429.00
3' x 50'	AT6044	\$599.00
6' x 50'	AT6039	\$959.00
12' x 50'	AT6040	\$1,659.00



# AGILITY TURF TRAINING NEXT LEVEL



**(A) Agility Turf with Hashmarks**

This is a premium padded artificial turf that is used in some of the top gyms and training centers in the country. Inlaid 24" hashmarks every yard allows for more precise training. High quality realistic yarns and fibers make it look and feel like real grass. Turf has a soft feel for athletes but holds up to high traffic areas and high impact workouts. Includes 5mm foam padding and does not require infill.

12' x 50'	\$4,099.00
12' x 60'	\$4,800.00
12' x 75'	\$5,999.00
12' x 90'	\$7,250.00

**Agility Turf with Yard Line Markers**

This is a premium padded artificial turf that is used in some of the top gyms and training centers in the country. Inlaid turf lines every five yards, that allows for more precise training. High quality realistic yarns and fibers make it look and feel like real grass. Turf has a soft feel for athletes but holds up to high traffic areas and high impact workouts. Includes 5mm foam padding and does not require infill.

12' x 50'	\$2,900.00
12' x 60'	\$3,400.00
12' x 75'	\$4,250.00
12' x 90'	\$4,999.00



A \*Double foot planks shown here

### (A) Single/Double Tip N' Roll Bleachers

Tip N' Roll Bleachers are perfect for auxiliary seating and come with double foot planks for added stability and comfort. The welded aluminum angle frame delivers a sturdy set of bleachers. Unit easily tips up on its casters for convenient storage. The high-grade swivel casters & rubber foot pads will not mark your floors. Seat planks are either anodized or powder coated (where applicable) Available as standard (single footboard) or preferred (double footboard).

ROWS	SEATS	ITEM	PRICE
2 Rows	10	BL7406	\$442.00
2 Rows	20	BL7407	\$673.00
2 Rows	28	BL7408	\$916.00
3 Rows	15	BL7409	\$596.00
3 Rows	30	BL7410	\$951.00
3 Rows	42	BL7411	\$1,296.00
3 Rows	54	BL7721	\$2,385.00
4 Rows	20	BL7412	\$1,517.00
4 Rows	40	BL7413	\$1,422.00
4 Rows	56	BL7414	\$1,740.00

\*Also available in 3 & 4-row low rise

### (B) Low-Rise Bleachers

Specially designed frames allow up to four rows of seating without the need for chain-link fencing. Frames are 100% welded aluminum angle. First row has a seat height of 10.5". Top row has a seat height of 30". Planks are 10" wide. Seat planks are anodized aluminum and won't rub off on clothes. Due to constantly changing specifications, please check local building and safety codes to ensure bleacher compliance. Call about double plank options.

LENGTH	ROWS	SEATS	ITEM	PRICE
7.5'	4	20	BL7601	\$727.00
15'	4	40	BL7611	\$1,264.00
21'	4	56	BL7621	\$1,749.00

### (C) Bleachers Without Fencing

Frames are 100% welded aluminum angle. Planks are 10"W. Come with safety end caps; no sharp edges to snag clothing or skin. Bleachers can be moveable or fastened to a concrete slab (Hardware not included).

LENGTH	ROWS	BENCH	ITEM	PRICE
15'	3 Rows	Single Plank	BL7742	\$854.00
15'	3 Rows	Double Plank	BL7747	\$1,049.00
21'	3 Rows	Single Plank	BL7752	\$1,188.00
21'	3 Rows	Double Plank	BL7757	\$1,455.00
27'	3 Rows	Single Plank	BL7762	\$1,522.00
27'	3 Rows	Double Plank	BL7763	\$1,877.00





### (D) Bleachers With Fencing

Frames are 100% welded aluminum angle. Planks are 10" W. Bleachers include guardrail system and riser boards. Colored bleachers include colored seat planks only.



LENGTH	ROWS	FOOT PLANK	FENCING	ITEM	PRICE
15'	5 Rows	Single	Standard Fence Railing	BL7645	\$2,876.00
15'	5 Rows	Single	Vertical Picket Railing	BL7646	\$3,462.00
15'	5 Rows	Double	Standard Fence Railing	BL7647	\$3,061.00
15'	5 Rows	Double	Vertical Picket Railing	BL7648	\$3,648.00
21'	5 Rows	Single	Standard Fence Railing	BL7649	\$3,712.00
21'	5 Rows	Single	Vertical Picket Railing	BL7650	\$4,456.00
21'	5 Rows	Double	Standard Fence Railing	BL7651	\$3,966.00
21'	5 Rows	Double	Vertical Picket Railing	BL7652	\$4,709.00
27'	5 Rows	Single	Standard Fence Railing	BL7653	\$4,611.00
27'	5 Rows	Single	Vertical Picket Railing	BL7654	\$5,516.00
27'	5 Rows	Double	Standard Fence Railing	BL7655	\$4,949.00
27'	5 Rows	Double	Vertical Picket Railing	BL7656	\$5,854.00

\*Available in 5, 8, 10 row options with 15', 21', 24', 27' lengths



### (E) VIP Bleachers

2" x 10" anodized aluminum seat planks (no discoloring). 2 - 2" x 10" foot planks on every row. Risers on every row. Fence railing on all models. 4.5' aisle with aluminum hand rail. Single and double footboards available.

LENGTH	ROWS	FENCING	ITEM	PRICE
21'	5	Standard Fence Rail	BL7765	\$4,858.00
21'	8	Standard Fence Rail	BL7769	\$7,887.00
27'	8	Standard Fence Rail	BL7770	\$9,697.00
21'	5	Vertical Picket Rail	BL7776	\$5,640.00
27'	10	Vertical Picket Rail	BL7785	\$13,923.00
21'	10	Vertical Picket Rail	BL7786	\$11,419.00



### (A) First Class Bleachers

First Class Bleachers feature welded aluminum angle frames, vertical aisle with handrail, vertical picket guardrail system. 4 row bleachers are 130" deep. 8 row bleachers are 276" deep. Gives your fans 50% more leg room (36" row spacing instead of 24"). Also provides a superior sight lines (14" rise instead of standard 8"). Has wider seat planks for added comfort (12" instead of 10"). 3-year limited warranty. Require on-site assembly.

NUMBER OF ROWS	BENCH SIZE	PRICE
4	19'	\$7,805.00
4	25'	\$12,999.99
4	31'	\$11,378.00
8	19'	\$16,160.00
8	25'	\$20,525.00
8	31'	\$23,471.00

### (B) Players Benches With Backs

Built for durability and comfort. Seat planks are 10" wide with a ribbed, non-slip surface. Planks are anodized aluminum; nothing will rub off on clothing. Bench comes with Safety End Caps in order to eliminate sharp edges to snag skin or clothing. Heavy-duty, commercial-grade galvanized steel legs are 2" outside diameter. In-ground and surface mount benches also available. 5-year guarantee.

MOUNT	LENGTH	SEATS	ITEM	PRICE
Portable Footing	7.5'	6	BL7400	\$353.00
Portable Footing	15'	10	BL7401	\$518.00
Portable Footing	21'	14	BL7402	\$653.00
Surface Mount	7.5'	6	BL7415	\$308.00
Surface Mount	15'	10	BL7416	\$473.00
Surface Mount	21'	14	BL7417	\$623.00
Permanent Mount	7.5'	6	BL7421	\$303.00
Permanent Mount	15'	10	BL7422	\$468.00
Permanent Mount	21'	14	BL7423	\$612.00
Portable Footing	27'	18	BL7497	\$736.00
Surface Mount	27'	18	BL7498	\$768.00

\* 24' also available







C

### (C) Players Benches Without Backs

5-year guarantee. Seat planks are 10" wide with a ribbed no-slip surface. Anodized aluminum planks keep aluminum from rubbing off on your clothing. Comes with safety end caps, with no sharp edges to snag clothing or skin. For indoor or outdoor use. Pre-drilled to be converted to indoor use.

MOUNT	LENGTH	SEATS	ITEM	PRICE
Portable Mount	7.5'	6	BL7403	\$200.00
Portable Mount	15'	10	BL7404	\$293.00
Portable Mount	21'	14	BL7405	\$381.00
Surface Mount	7.5'	6	BL7418	\$179.00
Surface Mount	15'	10	BL7419	\$262.00
Surface Mount	21'	14	BL7420	\$335.00
Permanent Mount	7.5'	6	BL7424	\$179.00
Permanent Mount	15'	10	BL7425	\$257.00
Permanent Mount	21'	14	BL7426	\$329.00
Permanent Mount	27'	18	BL7467	\$412.00
Surface Mount	27'	18	BL7468	\$412.00



### (D) Players Bench With Shelf

Features 10" powder-coated planks. 20" rear shelf for player/coach equipment. All-aluminum construction. Portable or surface mount (requires drilling holes in framework). 5-year limited warranty.

LENGTH	ITEM	PRICE
7.5'	BL7455	\$452.00
15'	BL7456	\$730.00
21'	BL7457	\$982.00
27'	BL7458	\$1,235.00



D

## TERMS AND CONDITIONS

For a full list of terms and conditions, visit [www.ondecksports.com/Terms](http://www.ondecksports.com/Terms)

### Ordering

Orders can be placed on our website at [www.ondecksports.com](http://www.ondecksports.com), or by calling 800.365.6171 (M-F 8:30a-5p est). Current prices apply at the time of shipment and are subject to change. Please refer to our website for the most up-to-date pricing.

### Sales Tax

State law requires us to collect sales tax from all Massachusetts, Connecticut, New York, Pennsylvania, and Georgia customers, unless they are otherwise exempt. Proof of tax exempt status will be required at the time of ordering. Customers in other states may incur sales tax when applicable.

### Shipping

All orders are shipped standard ground via Fed-ex or UPS when possible. In some cases, larger items will be required to ship via freight. Freight deliveries require a scheduled drop-off time, and the customer is responsible for unloading the truck and assessing the condition of the product upon delivery. All damage claims must be filed to On Deck Sports within 10 days of delivery.

### Return Policy

Products may be returned for a refund within 90 days of receiving your purchase. All returns require a return authorization number which can be acquired by calling our customer support team at 1-800-365-6171. Refunds are issued using the original form of payment. Items must be returned in their original condition, including packaging. Items are subject to a re-stocking fee of up to 20% depending on their condition at the time of the return. On Deck Sports is not responsible for misuse, or improper customer installation. Custom orders are not eligible for returns unless the item is defective or there was an error. Shipping charges are not refundable and customers are responsible for return shipping costs. Please include the return authorization number on all return packaging to ensure that return is processed in a timely fashion.

### Consumer Advisory and Warning

As with any physical activity, participation in athletics at any level comes with inherent risks of accidental injury. Under no circumstances should equipment used for these activities be altered, tampered with, or used when damaged. Such equipment should NEVER be used without direct adult supervision and only after examination for damage, wear, proper function, and proper maintenance. The equipment should never be employed for any activity other than that for which it was specifically aware of the risks involved in the activity they are participating in as well as their own physical limitations and that of the equipment being used.



150 Wood Road, Suite 200  
 Braintree, MA 02184  
 Phone: 800-365-6171 • Fax: 508-580-0211  
 info@OnDeckSports.com  
 www.OnDeckSports.com

PRST STD  
 U.S. Postage  
 PAID  
 On Deck Sports



**OFFICIAL SPONSOR OF**



**800.365.6171 • www.OnDeckSports.com**



A+ RATING



BECOME A FAN  
 @OnDeckSports



FOLLOW US  
 @OnDeckSports



FOLLOW US  
 @OnDeckSports



BLOG  
 blog.ondecksports.com